



СОДЕРЖАНИЕ

Фрезы пазовые.....	3
Фрезы пазовые раздвижные.....	4
Фрезы пазовые раздвижные с подрезателями.....	4
Фрезы для выборки четвертей.....	5
Фрезы для выборки четвертей составные.....	5
Фрезы для обработки галтелей, полугалтелей.....	6
Фрезы для обработки штапов, полуштапов.....	7
Фрезы для изготовления оконного штапика.....	8
Фрезы для изготовления дверного штапика.....	9
Фрезы для изготовления плинтуса.....	10-13
Фрезы для изготовления поручней.....	14
Фрезы для изготовления картинной рамки.....	15
Фрезы мультипрофильные.....	16
Фрезы для изготовления притворной планки.....	17
Фрезы для изготовления банной доски.....	18
Фрезы для изготовления кромки стола.....	19
Фрезы для обработки боковой кромки наличника.....	19
Фрезы для изготовления наличников.....	20
Фрезы для изготовления половой доски.....	21-23
Фрезы для изготовления обшивочной доски "Вагонки".....	24-29
Фрезы для изготовления воздушного паза.....	30
Фрезы для изготовления стенового бруса.....	31-33
Фрезы для изготовления окон.....	34-35
Фрезы для изготовления дверей.....	36-41
Фрезы для производства мебели.....	42-43
Фрезы цилиндрические сборные.....	44
Клинья.....	45
Валы.....	45
Содержание.....	46



Фрезы острозаточенные напайные пазовые

Материал режущей части - HM, HSS



Обозначение фрез	D, mm	d, mm	b, mm	z
01-099	125	32;40	4	4;6
01-100			5	
01-101			6	
01-102			8	
01-103			10	
01-104			12	
01-105			14	
01-106			16	
01-107			18	
01-108			20	
01-109	160	32;40;60	6	4;6
01-110			8	
01-111			10	
01-112			12	
01-113			14	
01-114			16	
01-115			18	
01-116			20	

Обозначение фрез	D, mm	d, mm	b, mm	z
01-117	180	32;40;60	6	4;6
01-118			8	
01-119			10	
01-120			12	
01-121			14	
01-122			16	
01-123			18	
01-124			20	
01-125	200	32;40;60	6	4;6
01-126			8	
01-127			10	
01-128			12	
01-129			14	
01-130			16	
01-131			18	
01-132			20	

Обозначение фрез	D, mm	d, mm	b, mm	z
01-133	220	32;40;60	10	4;6
01-134			12	
01-135			14	
01-136			16	
01-137	250	32;40;60	18	4;6
01-138			20	
01-139			10	
01-140			12	
01-141			14	
01-142			16	
01-143			18	
01-144			20	

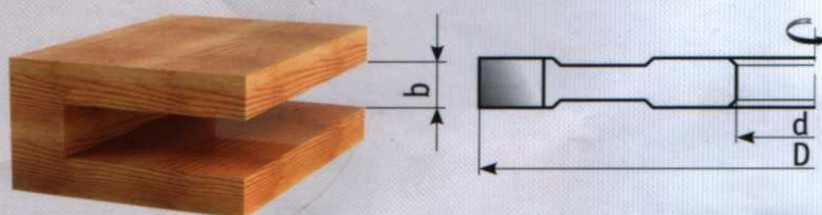



Фрезы раздвижные напайные пазовые

Материал режущей части - НМ, HSS

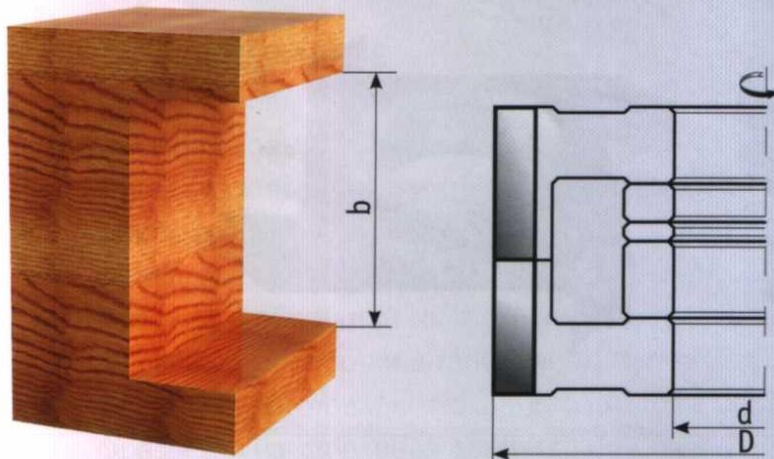

Обозначение фрез	D, mm	d, mm	b, mm	z
01-145	125	32	20...35	4
01-146	140			
01-147	160	32;40;60	40...75	
01-148	180			

Фрезы раздвижные напайные пазовые с подрезающими зубьями

Материал режущей части - НМ, HSS

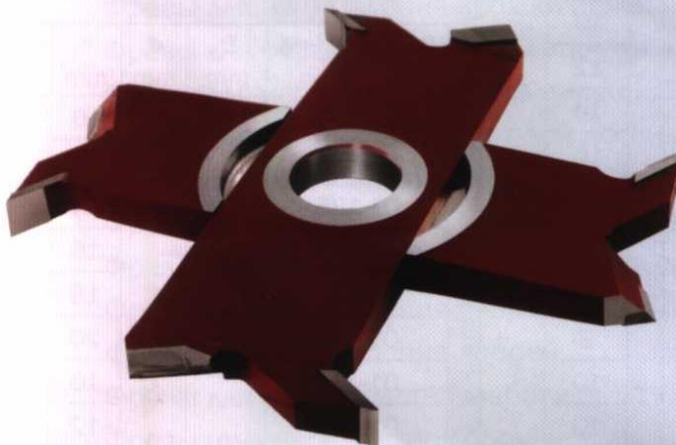

Обозначение фрез	D, mm	d, mm	B, mm	b, mm	z
01-149	200	32	12	12...20	4+4
01-150			20	20...35	

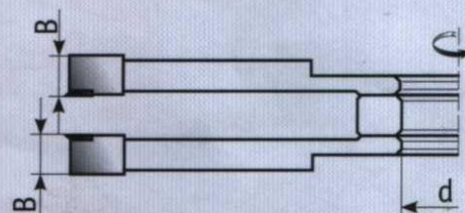
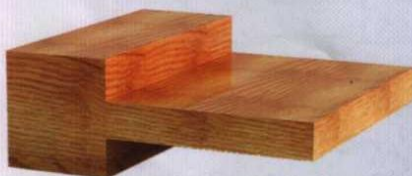
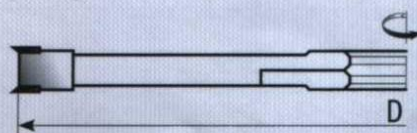



Фрезы для выборки четвертей Материал режущей части - HSS

Обозначение фрез	D, mm	d, mm	B, mm	b, mm	h, mm	z
01-245	125;160;180	32;40;60	32	16	6	4;6
01-246			40	20	8	
01-247			50	25	10	
01-248			60	30	12	
01-253			40	20		

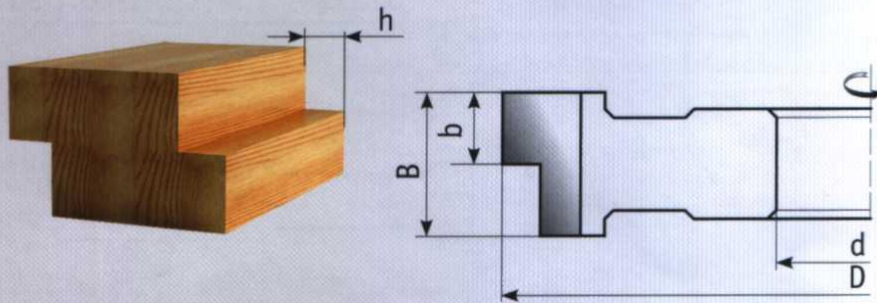
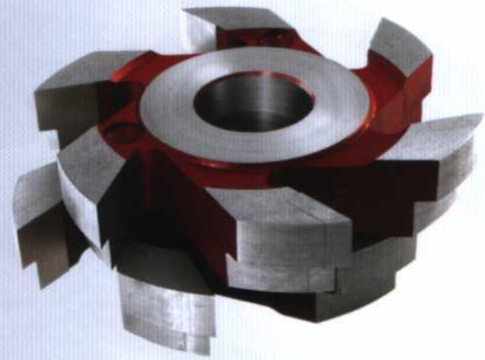

Фрезы составные для выборки четвертей Материал режущей части - HM, HSS

Обозначение фрез	D, mm	d, mm	B, mm	b, mm	h, mm	z
01-270	125;160;180	32;40;60	32	16	10	6
01-271			40	20		
01-272			50	25		
01-273			60	30		
01-274			32	16	12	
01-275			40	20		
01-276			50	25		
01-277			60	30		

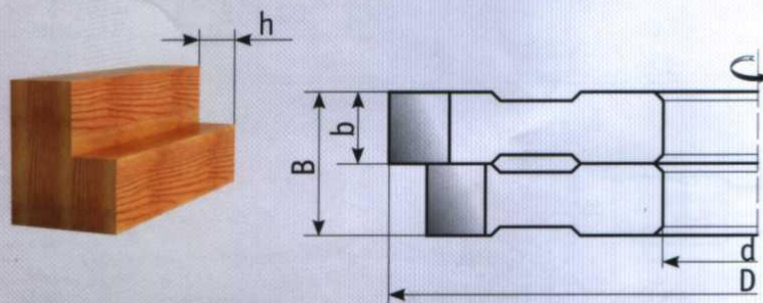



Фрезы для обработки галтелей

Материал режущей части - HSS

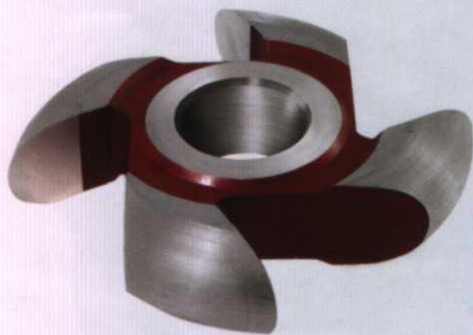

Обозначение фрез	D, mm	d, mm	B, mm	R, mm	h, mm
02-101	125	32	6	3	4
02-102			8	4	
02-103			10	5	
02-104			12	6	
02-105			16	8	
02-106			20	10	
02-107			24	12	
02-108			28	14	
02-109			32	16	
02-110			36	18	
02-111			40	20	
02-112	140	32	50	25	
02-113			60	30	

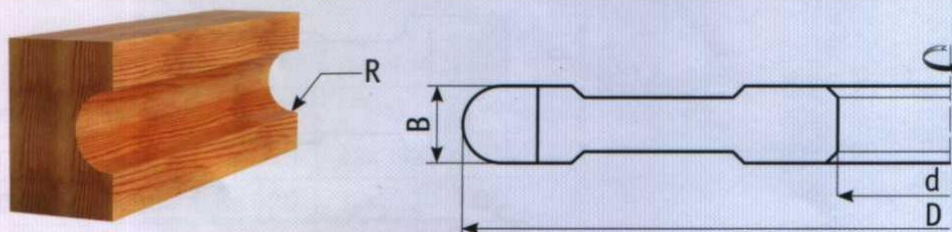

Фрезы для обработки полугалтелей

Материал режущей части - HSS



Левые						Правые		
Обозначение фрез	D, mm	d, mm	B, mm	R, mm	z	Обозначение фрез		
02-346	125	32	7	3	4	02-331		
02-347				4		02-332		
02-348			8	5		02-333		
02-349			9	6		02-334		
02-350			12	8		02-335		
02-351			15	10		02-336		
02-352			17	12		02-337		
02-353			19	14		02-338		
02-354			21	16		02-339		
02-355			23	18		02-340		
02-356			25	20		02-341		
02-357			140	32		30	25	02-342
02-358						35	30	02-343





Фрезы для обработки штапов Материал режущей части - HSS

Обозначение фрез	D, mm	d, mm	B, mm	R, mm	z
02-216	125	32	12	3	4
02-217			14	4	
02-218			16	5	
02-219			18	6	
02-220			22	8	
02-221			30	10	
02-222			34	12	
02-223			38	14	
02-224			42	16	
02-225			46	18	
02-226			50	20	
02-227	140	32	60	25	4
02-228			70	30	

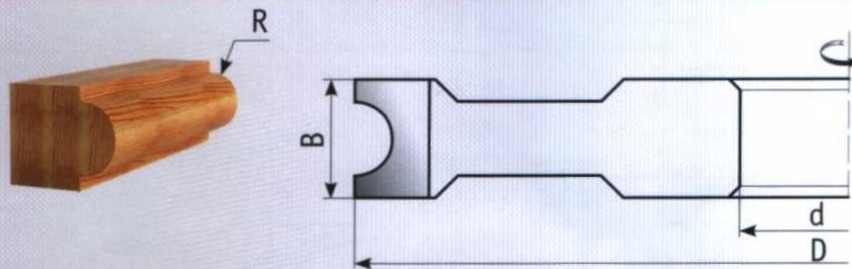
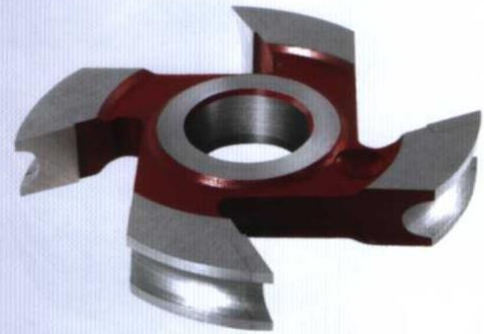

Левые

Правые

Обозначение фрез	D, mm	d, mm	B, mm	R, mm	z	Обозначение фрез		
02-481	125	32	7	3	4	02-460		
02-482				4		02-461		
02-483			8	5		02-462		
02-484			9	6		02-463		
02-485			12	8		02-464		
02-486			15	10		02-465		
02-487			17	12		02-466		
02-488			19	14		02-467		
02-489			21	16		02-468		
02-490			23	18		02-469		
02-491			25	20		02-470		
02-492			140	32		30	25	02-471
02-493						35	30	02-472

Фрезы для обработки полуштапов Материал режущей части - HSS

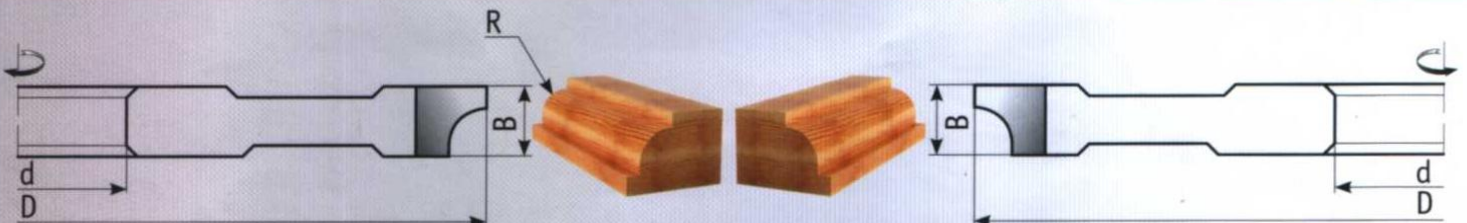



Фрезы для изготовления оконного штапика

Материал режущей части - HSS

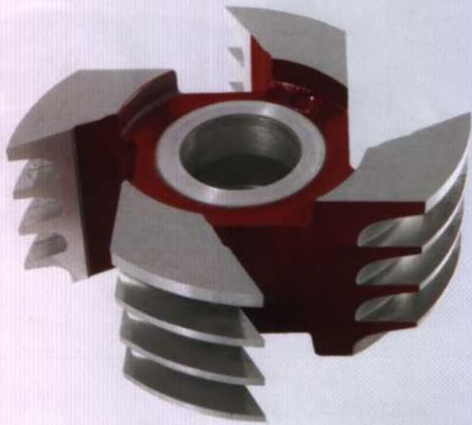

Обозначение фрез	D, mm	d, mm	z
03-100	125; 160; 180;	32; 40; 60	4;6
03-102			
03-104			

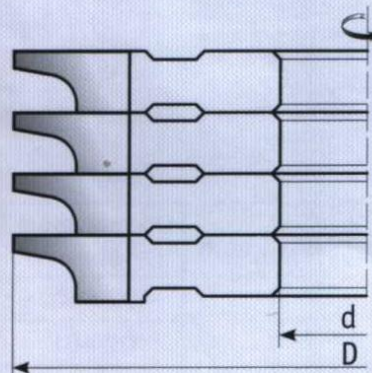
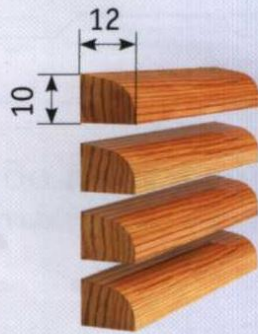

03-100

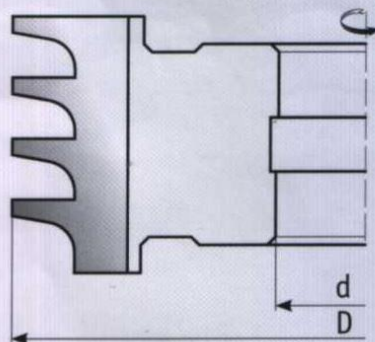

03-104

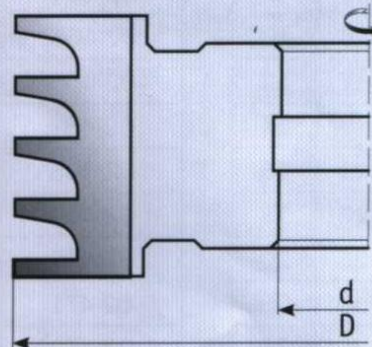

03-102



Комплект фрез для изготовления дверного штапика

Материал режущей части - HSS

Обозначение фрез	D, mm	d, mm	z
03-157	130	32	4
03-158			
03-159			

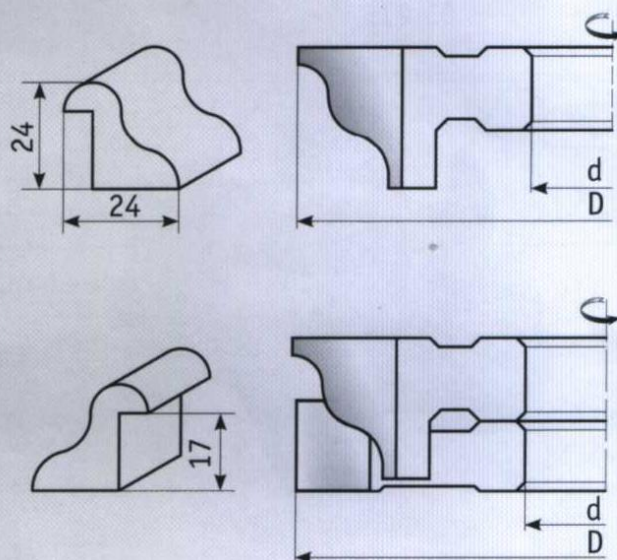
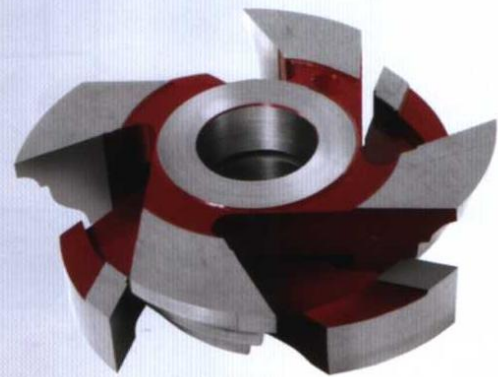

03-157



03-158



03-159



Комплект фрез для изготовления плинтуса

Материал режущей части - HSS

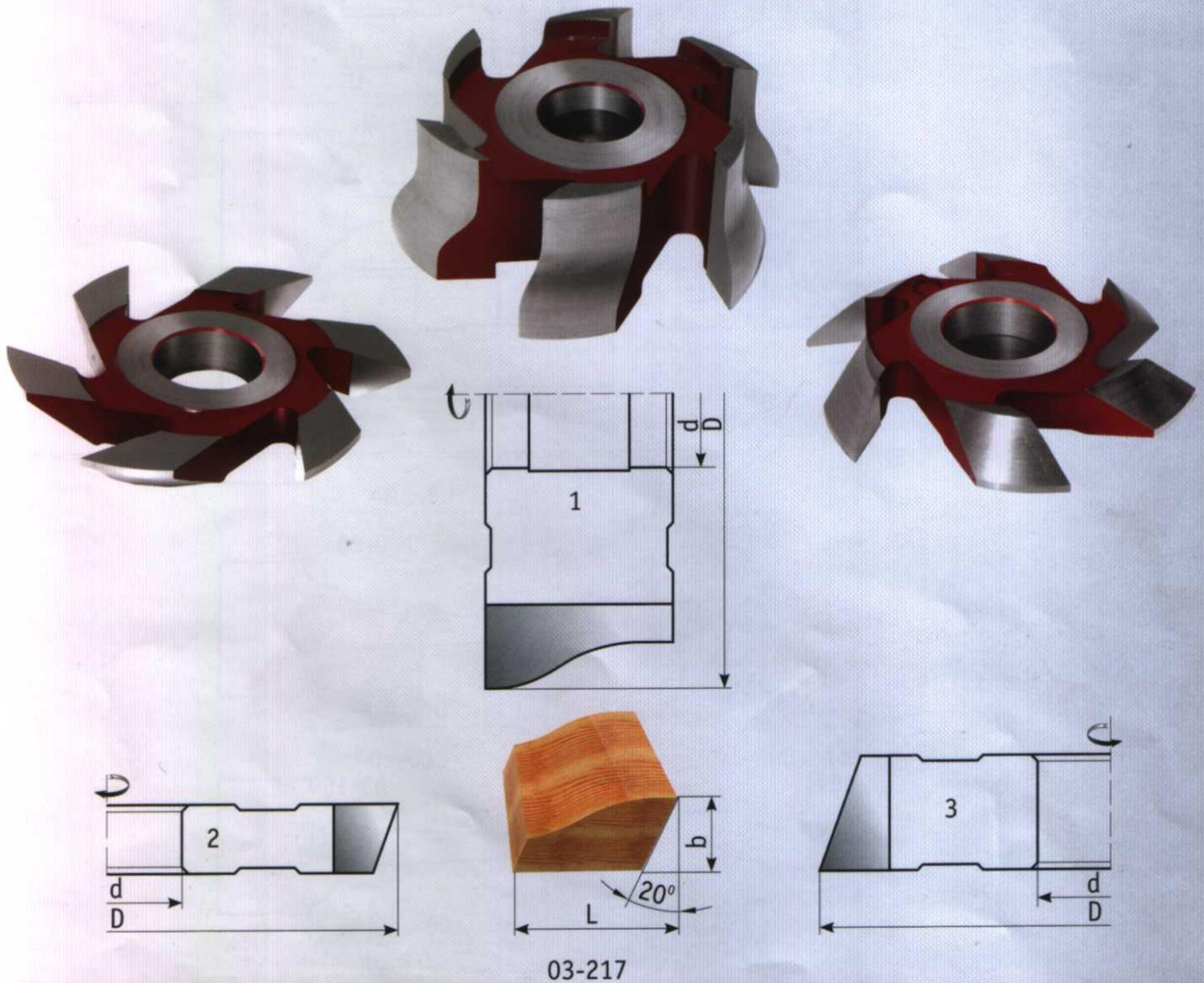
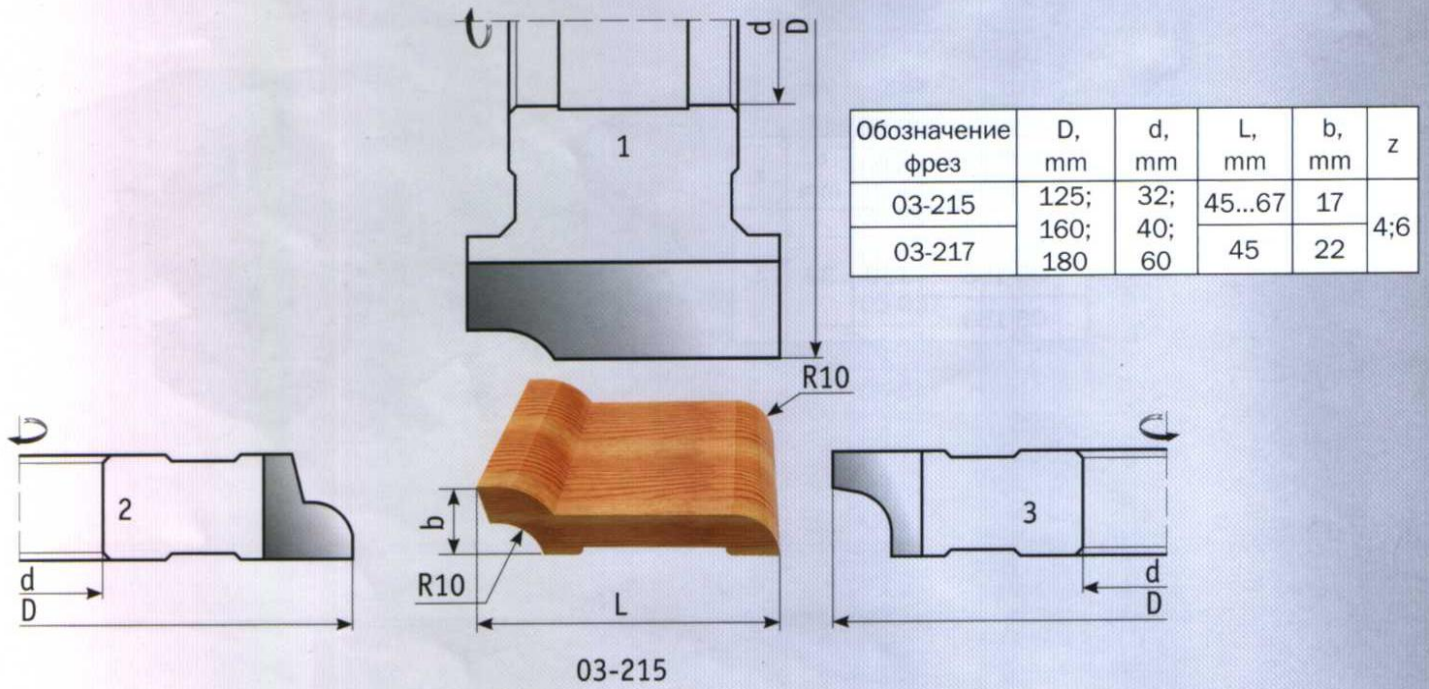



Комплект фрез для изготовления плинтуса Материал режущей части - HSS

Обозначение фрез	D, mm	d, mm	L, mm	z
03-216	125;160;180;	32; 40; 60	30...45	4;6
03-218				
03-224				
03-225				
03-226				
03-231				

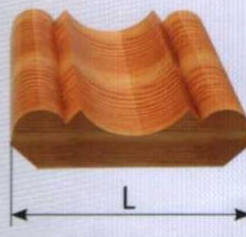
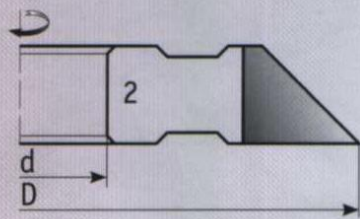
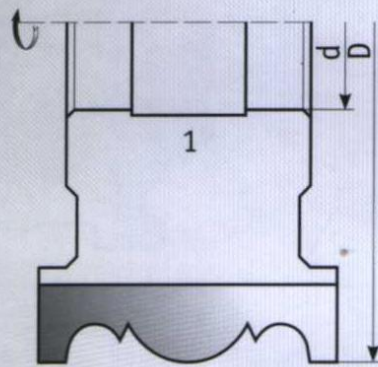

03-216

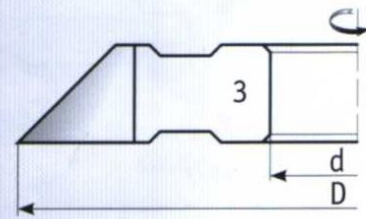

03-218



03-224



03-225



03-226



03-231



Фрезы для изготовления плинтуса

Материал режущей части - HSS

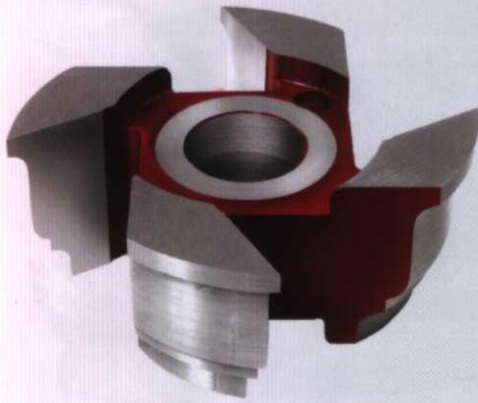

Обозначение фрез	D, mm	d, mm	L, mm	z
03-240	125;160;180;	32; 40; 60	30...45	4;6
03-241				
03-242				
03-243				
03-244				
03-245				

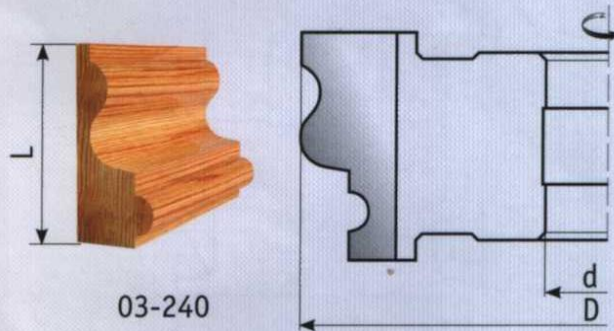

03-240

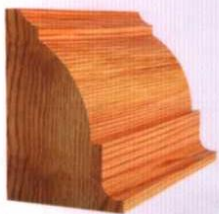

03-241



03-242



03-243



03-244



03-245



Фрезы для изготовления плинтуса Материал режущей части - HSS

Обозначение фрез	D, mm	d, mm	L, mm	L1, mm	z
03-250	125;160	32; 40	50...70	~	4;6
03-251					

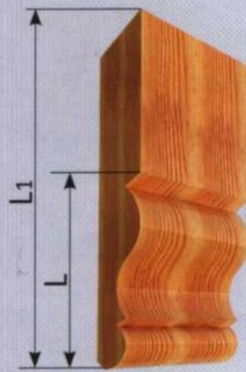
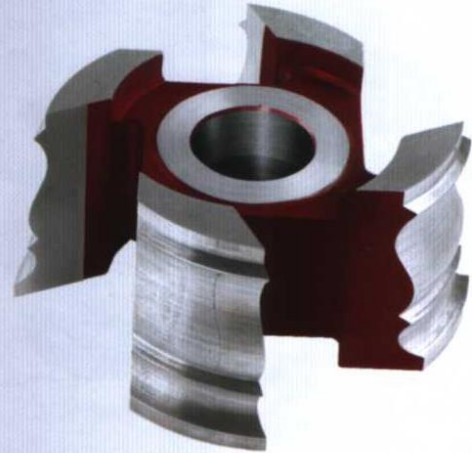

03-250

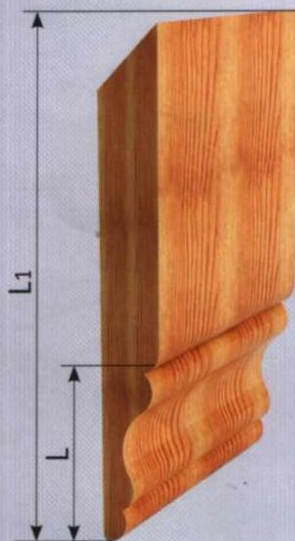
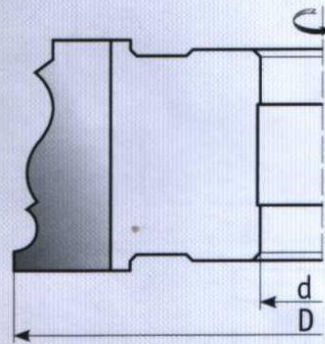

03-251

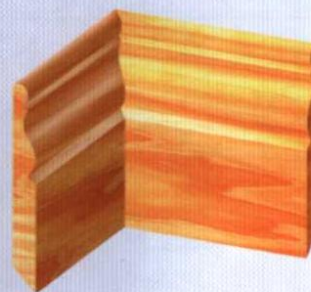



Комплект фрез для изготовления поручней

Материал режущей части - HSS

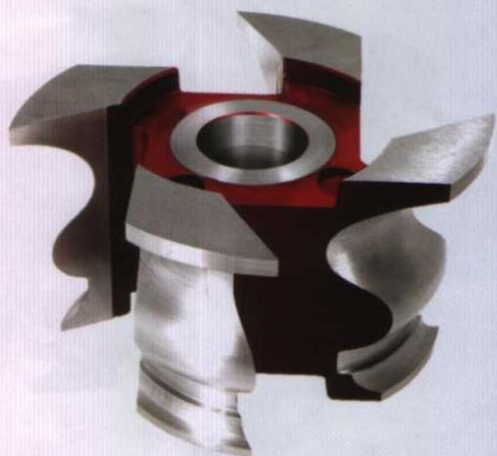

Обозначение фрез	D, mm	d, mm	b, mm	z
03-350	125;160;180	32; 40;60	65	4;6
03-356			45	
03-357			65	
03-358			65	

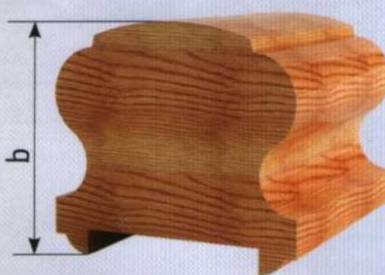
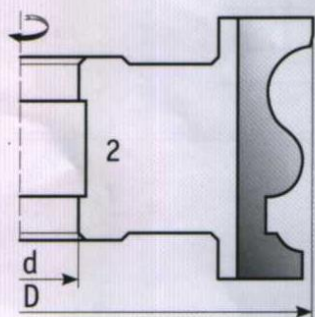
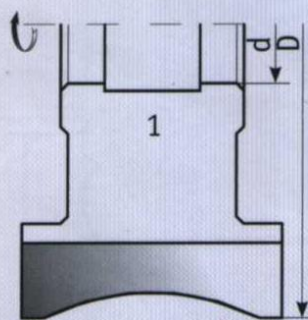

03-350

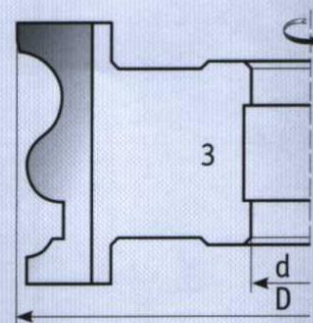

03-356

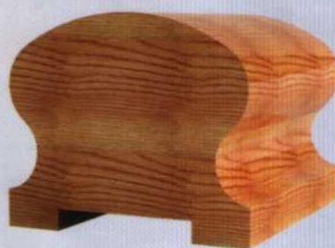

03-357

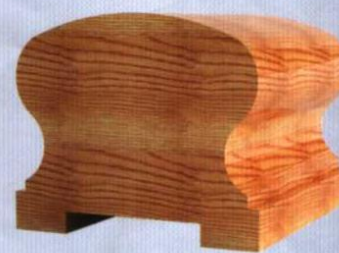

03-358



Комплект фрез для изготовления картинной рамки

Материал режущей части - HSS

Обозначение фрез	D, mm	b, mm	z
03-400	125	32	4

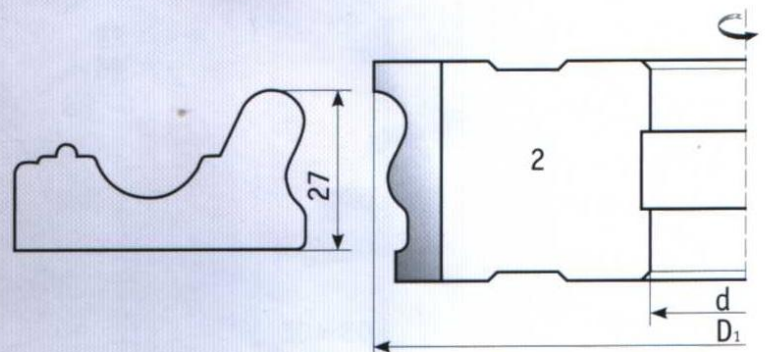
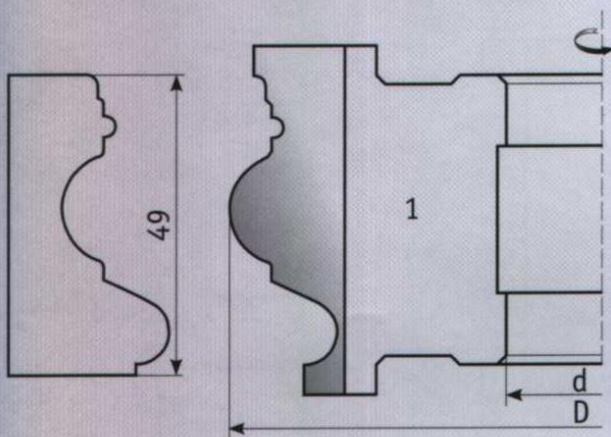
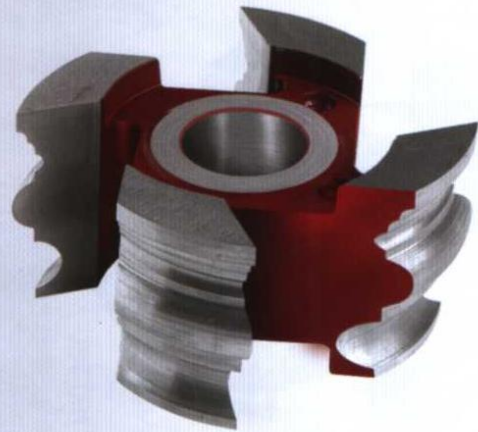

03-400



Фрезы мультипрофильные

Материал режущей части - HSS



Обозначение фрез	D, mm	d, mm	b, mm	z
03-402	125	32	47	4
03-403			25	

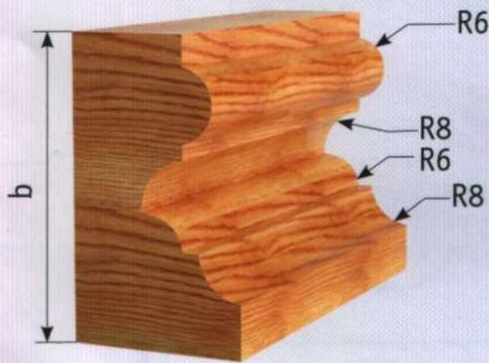

03-402

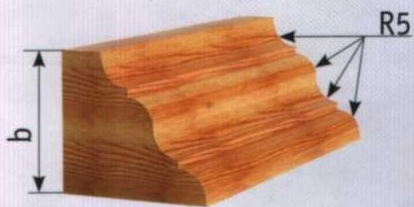
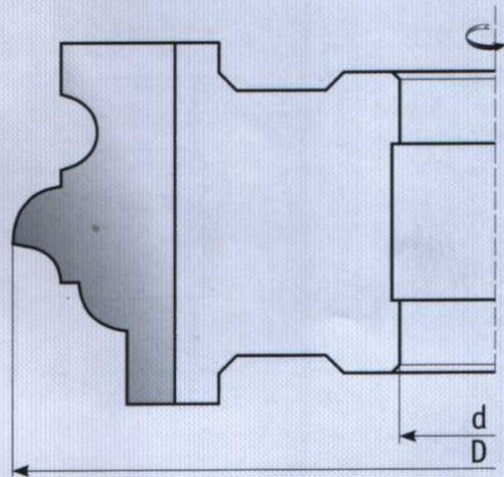

03-403

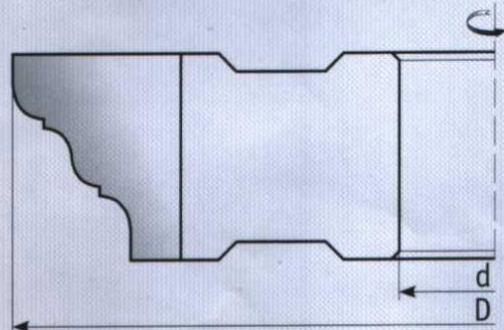



Фрезы фасонные для изготовления притворной планки

Материал режущей части - HSS

Обозначение фрез	D, мм	d, мм	h, мм	z
03-404	125	32	12	4
03-405				
03-406				
03-407				
03-408				

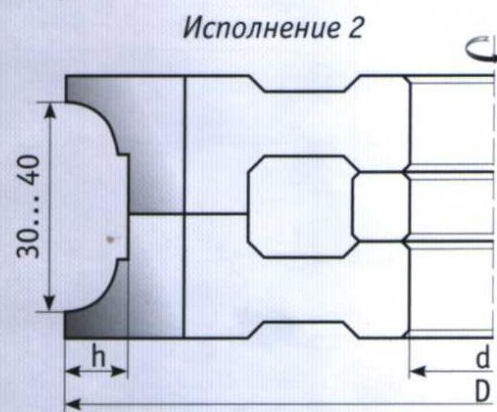
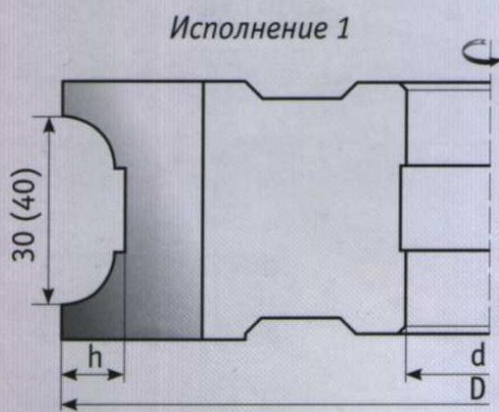
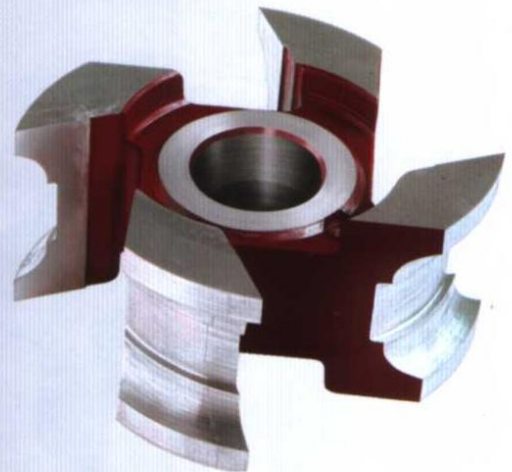

03-404



03-405



03-406



03-407



03-408



Комплект фрез для изготовления фасонных изделий

Материал режущей части - HSS

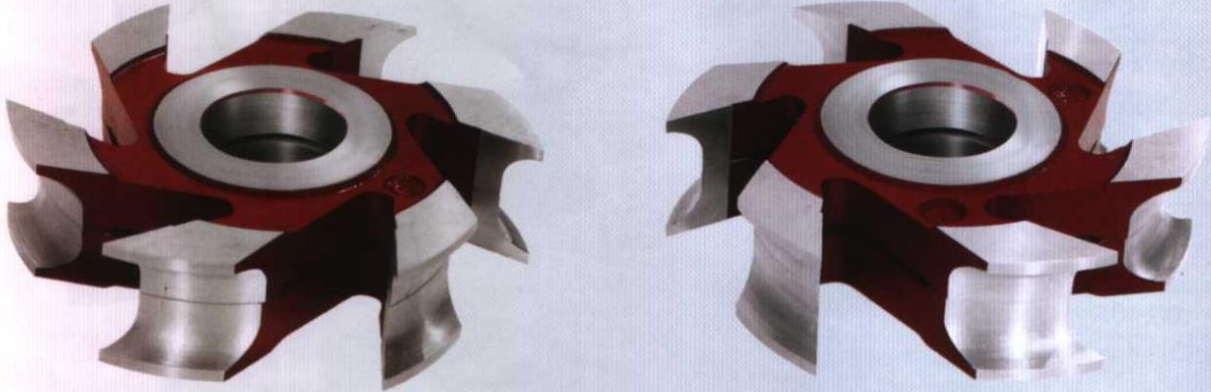

Обозначение фрез	D,mm	d,mm	b,mm	R,mm	z
03-482	125; 160; 180	32; 40; 60	11...30	5...10	4;6
03-483			20...45		

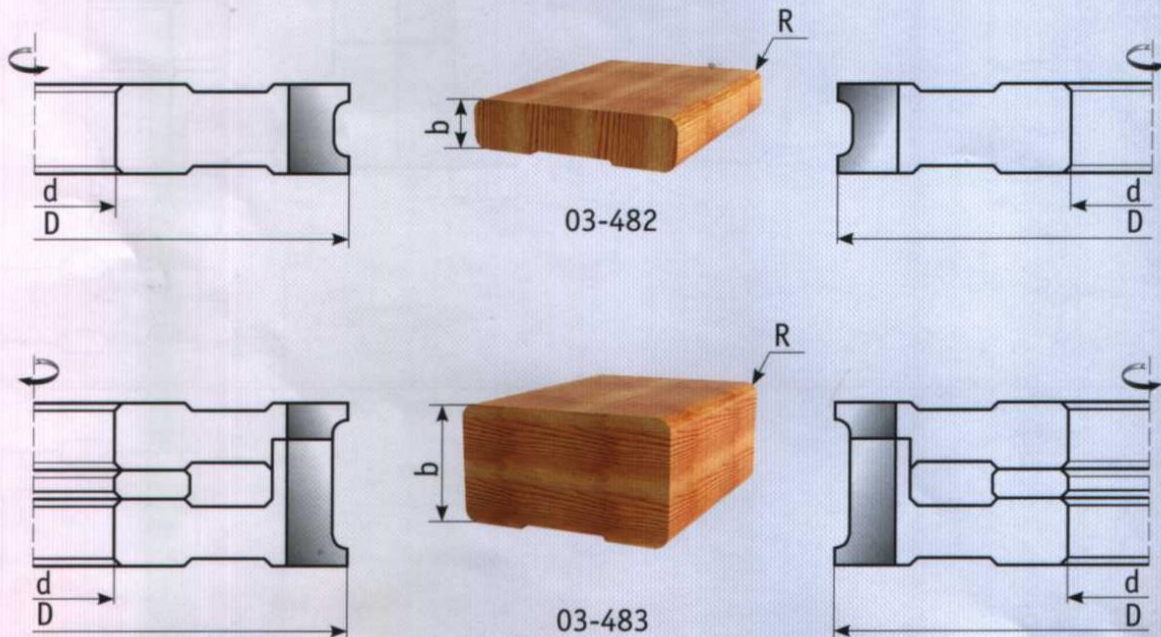



Комплект фрез для обработки боковой кромки наличника Материал режущей части - HSS

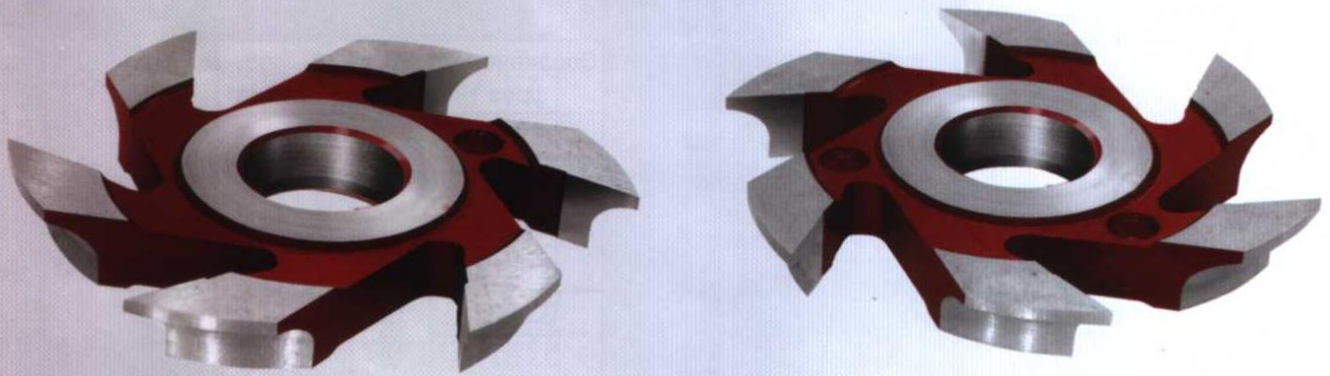

Обозначение фрез	D, mm	d, mm	B, mm	b, mm	R, mm	z
03-490	125;160;180	32;40;60	22	18	10;12	4;6
03-495	160	32		55	-	4



Комплект фрез для изготовления кромки стола Материал режущей части - HSS

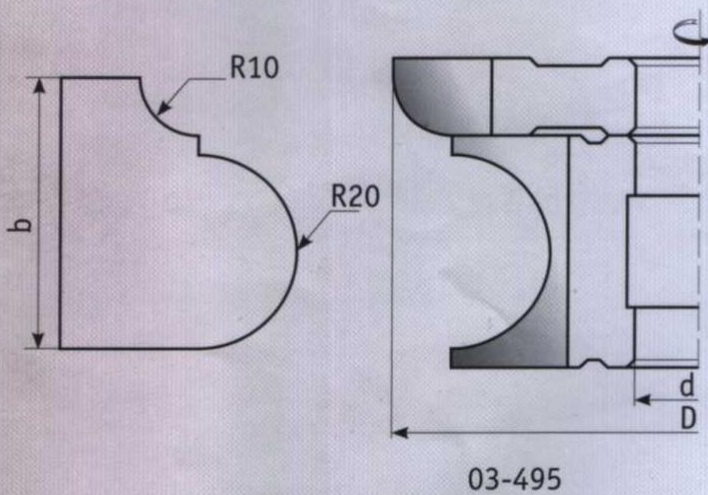



Фрезы для изготовления наличников

Материал режущей части - HSS



Обозначение фрез	D, mm	d, mm	b, mm	z
03-565	125;160;180;	32; 40; 60	70	4;6
03-566				
03-572				
03-573				
03-574				
03-575				
03-577				
03-578				

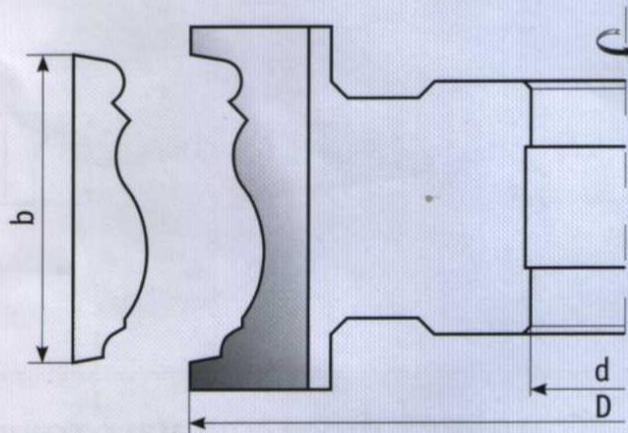

03-565



03-566



03-572



03-573



03-574



03-575



03-577



03-578



Комплект фрез для изготовления половой доски Материал режущей части - HSS

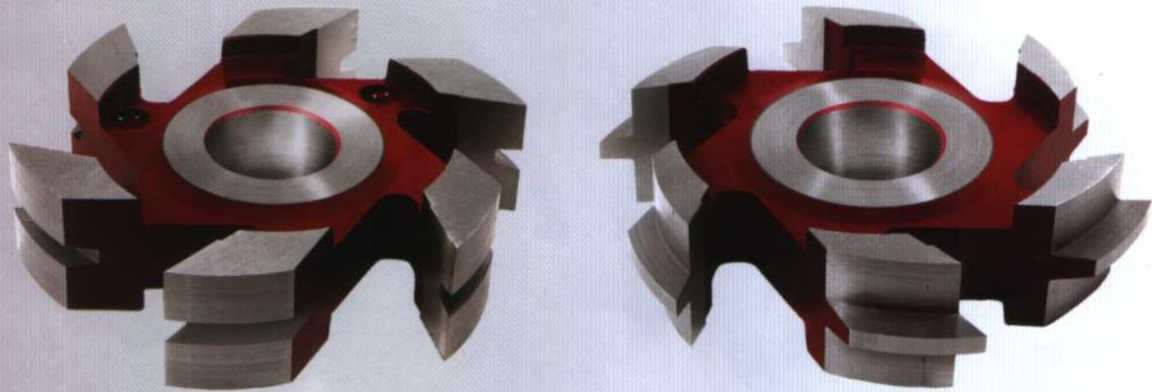

Обозначение фрез	D, mm	d, mm	B, mm	b, mm	h, mm	h1, mm	z
03-601	125	32	35	6	9	8	4
03-603			40	7			
03-605			45	8			
03-607			50	10			
03-609	160	40;60	35	6	9	8	6
03-611			40	8			
03-613			45	9			
03-615			50	10			
03-617	180	60	35	6	9	8	6
03-619			40	8			
03-621			45	9			
03-623			50	10			

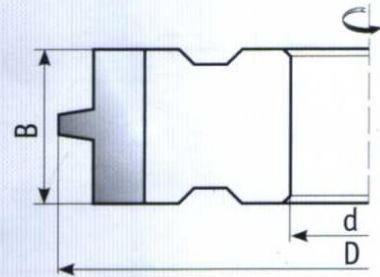
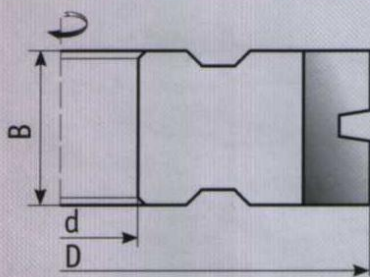

Исполнение 1

Исполнение 2

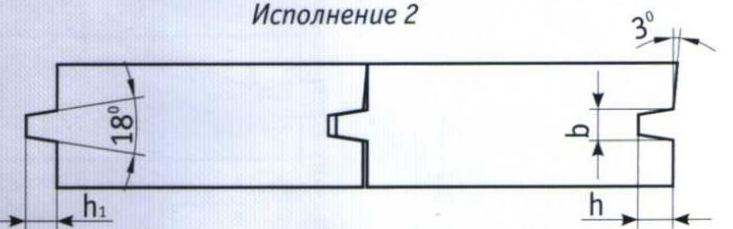
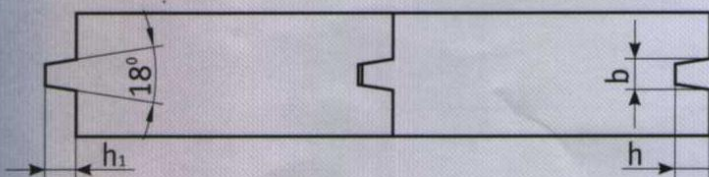

Исполнение 3

Исполнение 4

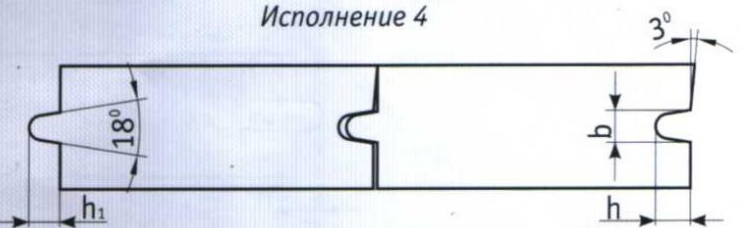
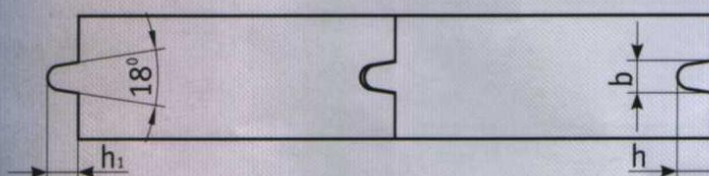



Комплект фрез для изготовления половой доски

Материал режущей части - HSS

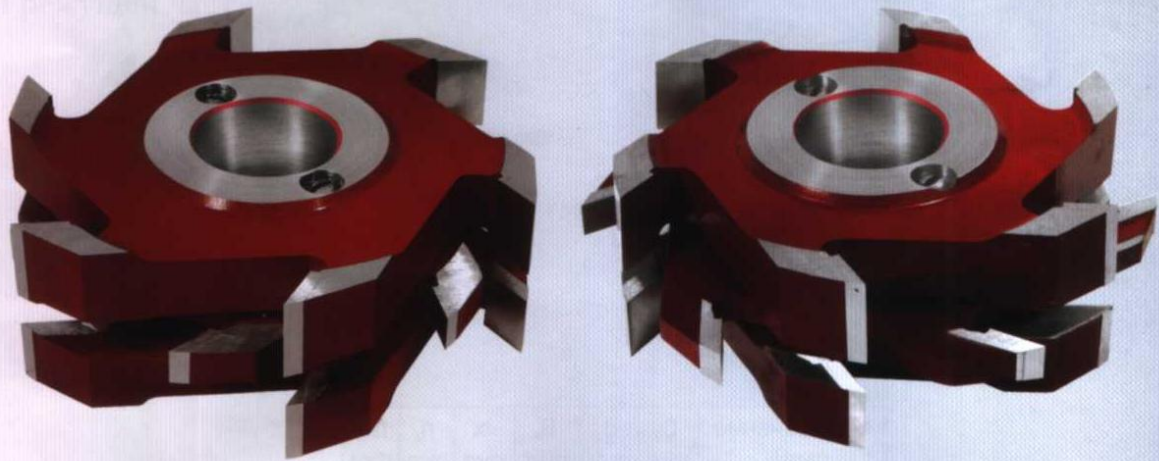

Обозначение фрез	D, mm	d, mm	B, mm	b, mm	h, mm	b1, mm	z
03-625	125	32	40	6	6	7	6
03-627			50	9		10	
03-629	160	40	40	6		7	
03-631			50	9		10	
03-633	180	40;60	40	6		7	
03-635			50	9		10	

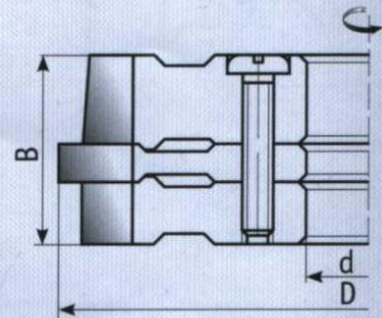
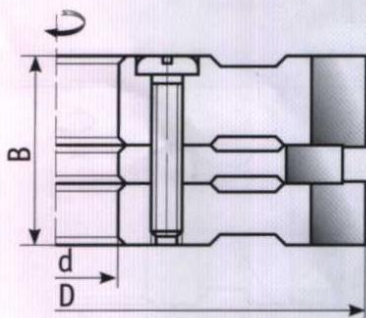

Исполнение 1

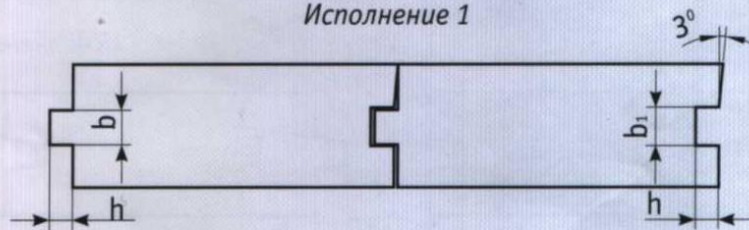

Исполнение 2





Комплект фрез для изготовления половой доски

Материал режущей части - HSS

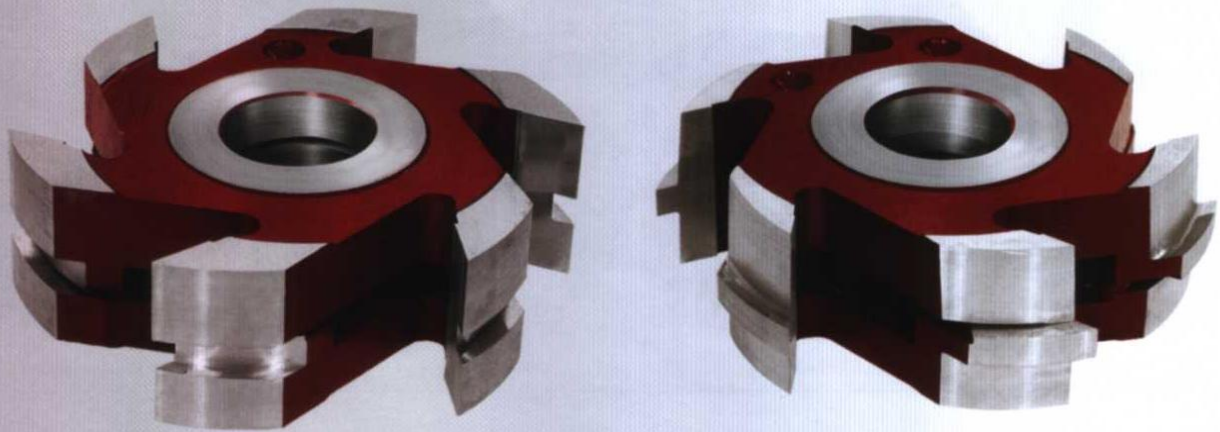

Обозначение фрез	D,mm	d,mm	B,mm	b,mm	h,mm	b1,mm	z
03-0305	160;180	40;60	40	6	6	7	6
03-0306			50	9		10	

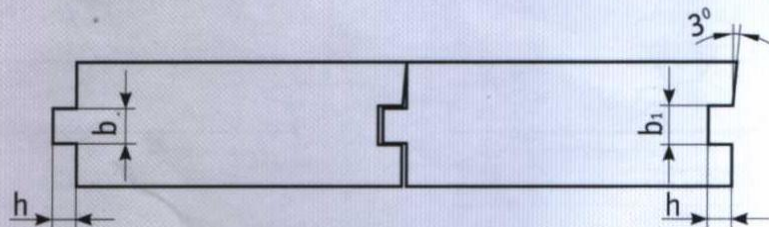
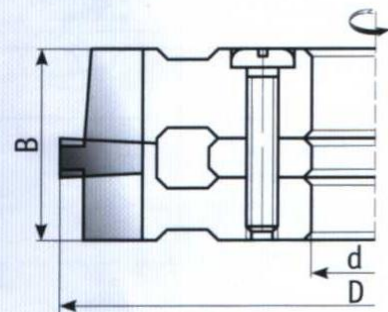
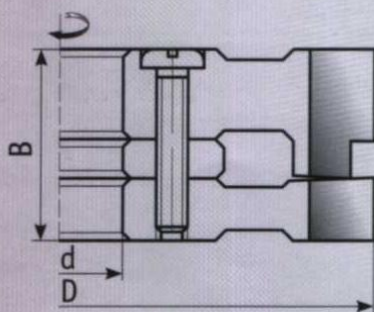



Комплект фрез для изготовления обшивочной доски "Вагонка"

Материал режущей части - HSS



d \ D	32	40	60	z
130	x	x		4
160		x		6
180		x	x	

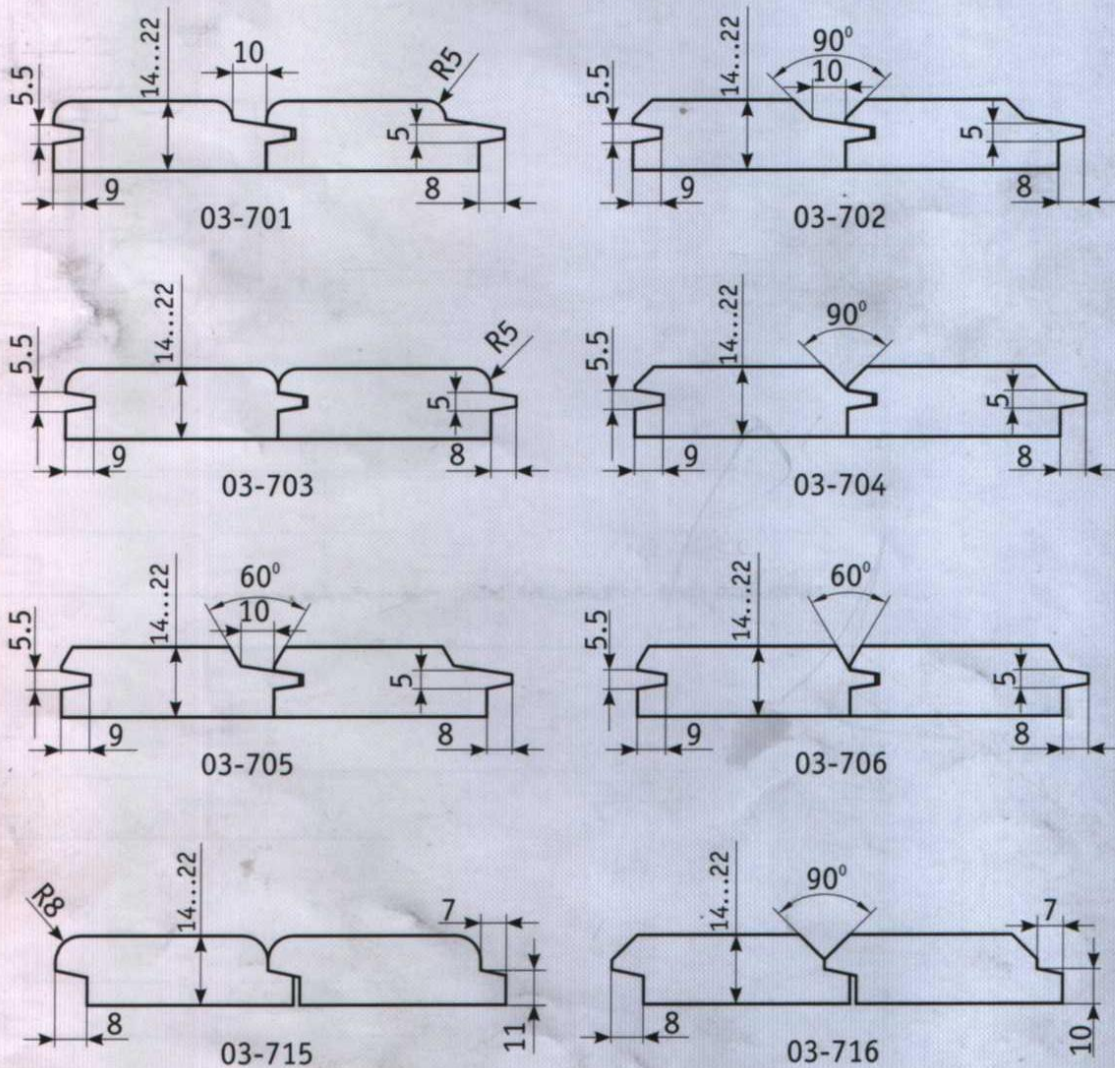



Комплект фрез для изготовления обшивочной доски "Вагонка"
 Материал режущей части - HSS



d	40	60	z
D	x		6
160	x		
180		x	

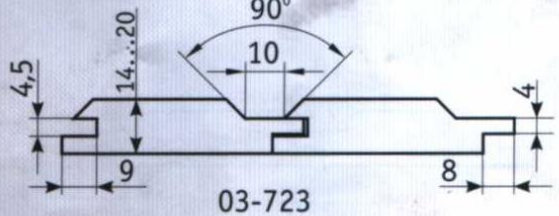
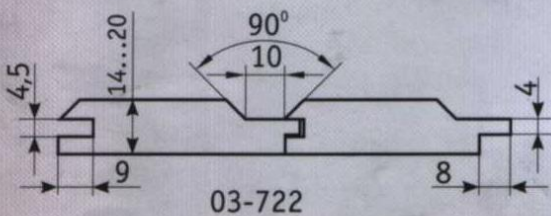
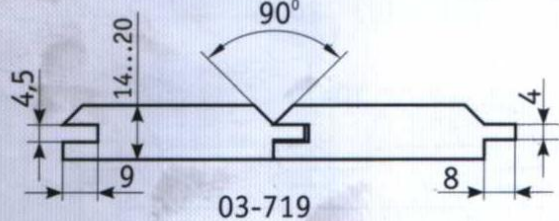
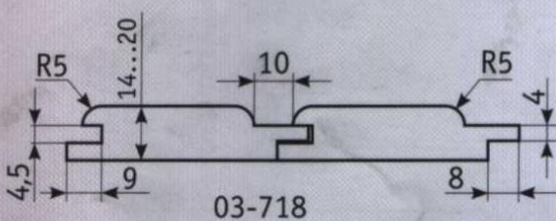
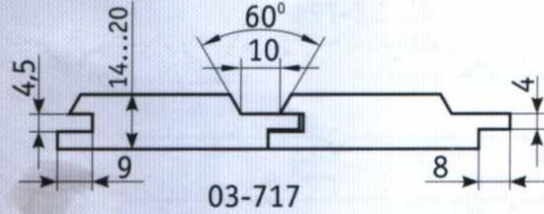
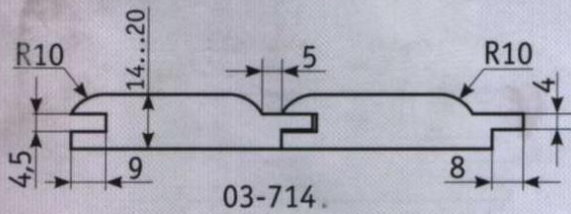
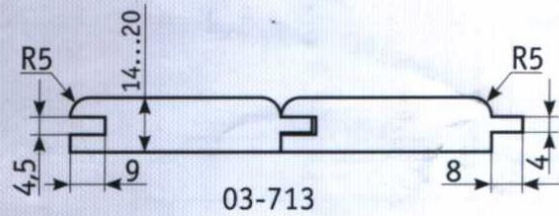
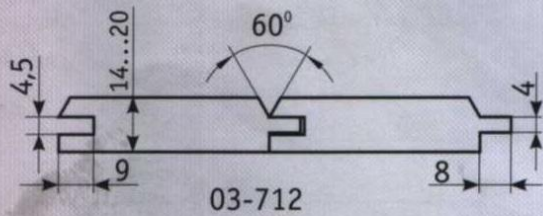
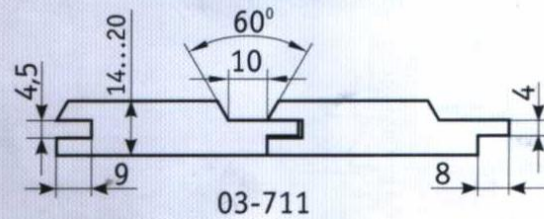
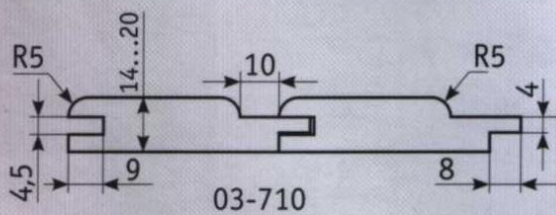
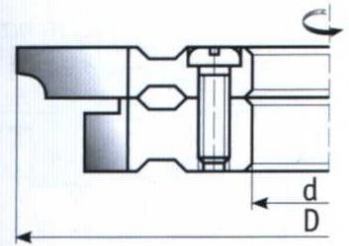
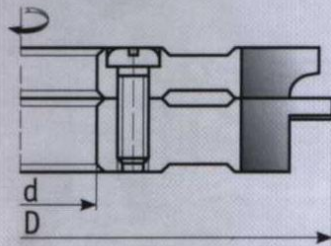



Комплект фрез для изготовления обшивочной доски "Вагонка"

Материал режущей части - HSS

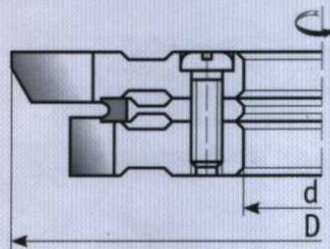
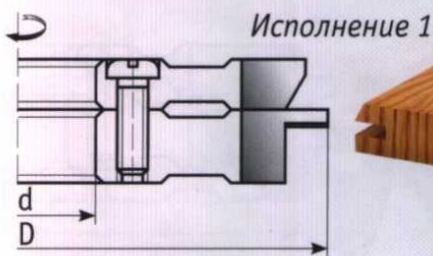
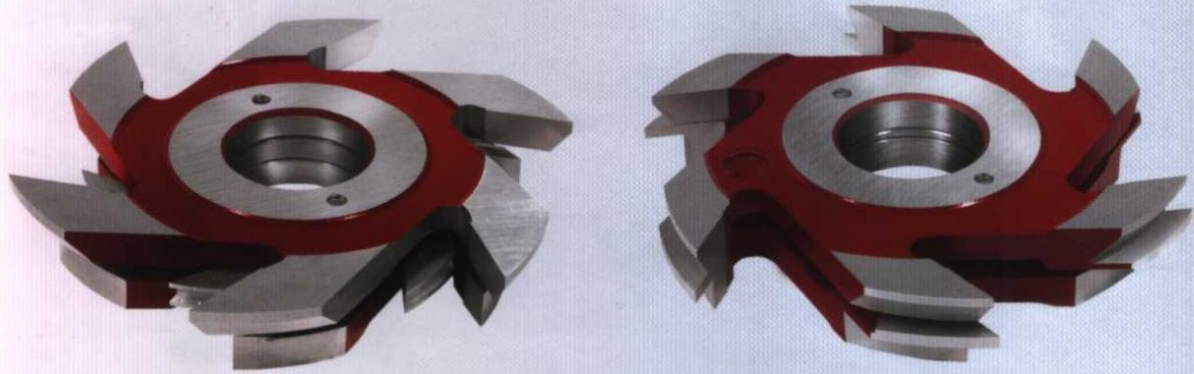

d	40	60	z
D	x		6
160	x		
180		x	

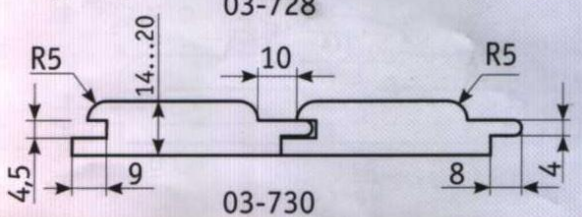
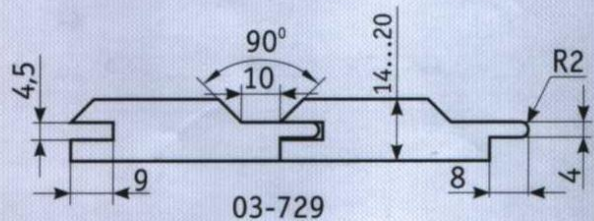
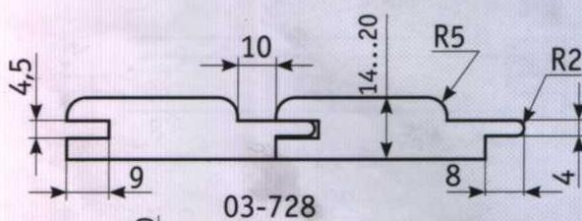
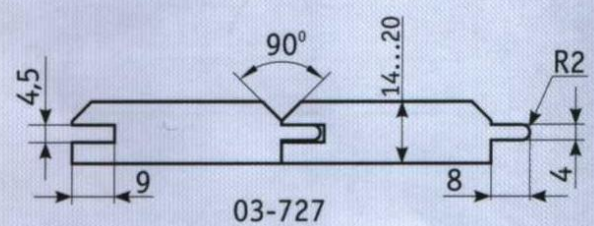
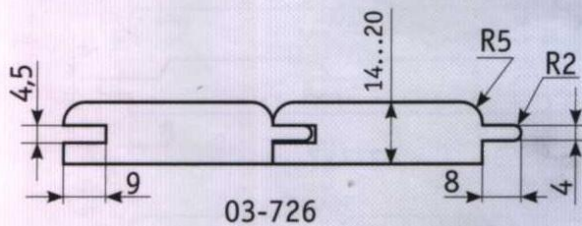
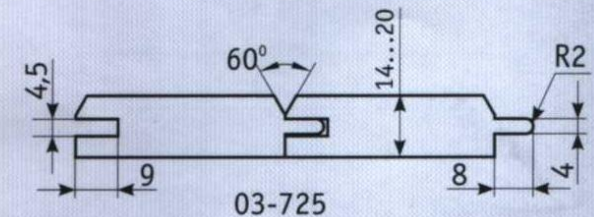
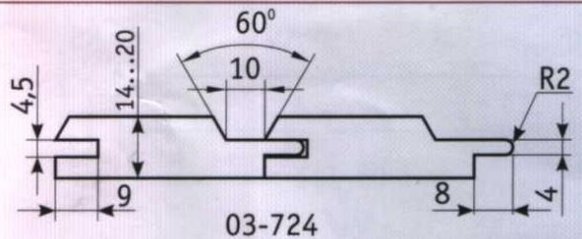
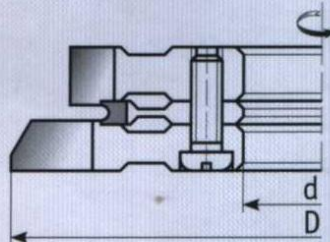
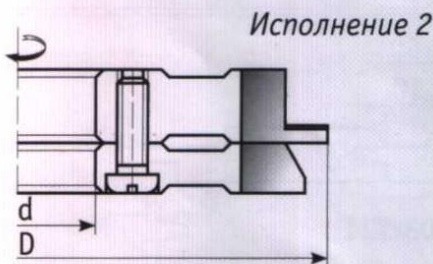



Комплект фрез для изготовления обшивочной доски "Имитация бруса"
Материал режущей части - HSS

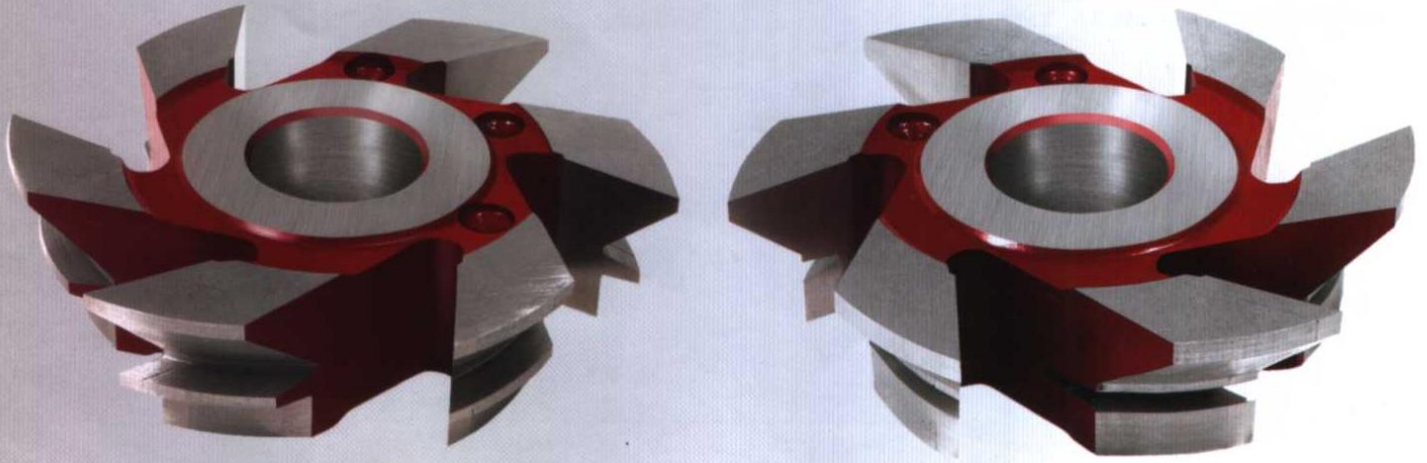

d \ D	40	60	z
160	x		6
180		x	

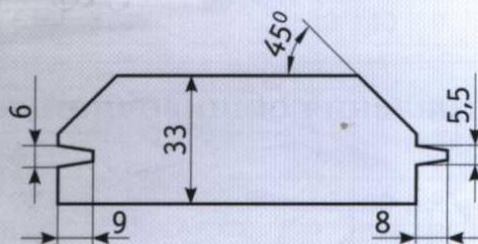
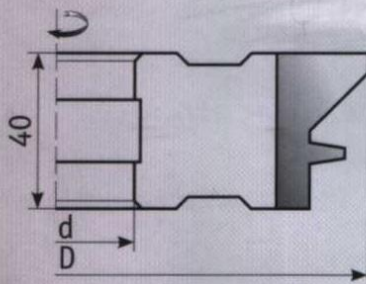

03-731

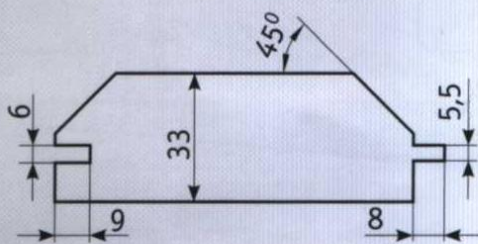
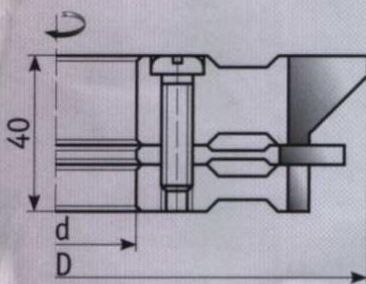
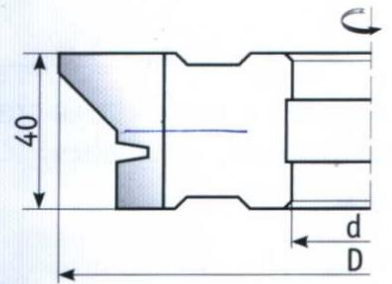

03-732

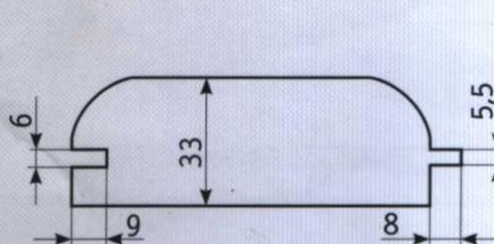
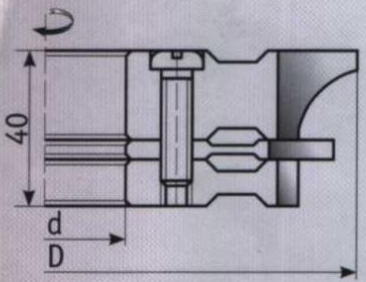
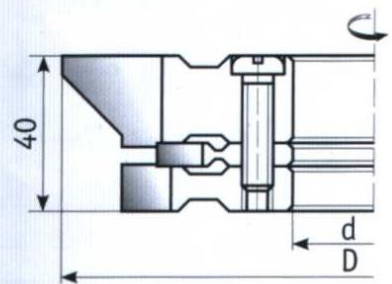

03-733

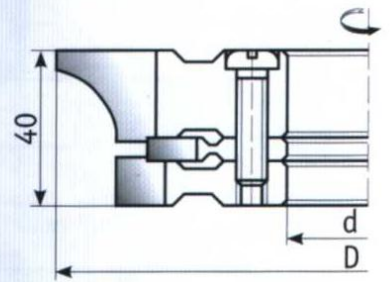



Универсальный комплект фрез для изготовления:
 половой доски; паркета; обшивочной доски
 Материал режущей части - HSS

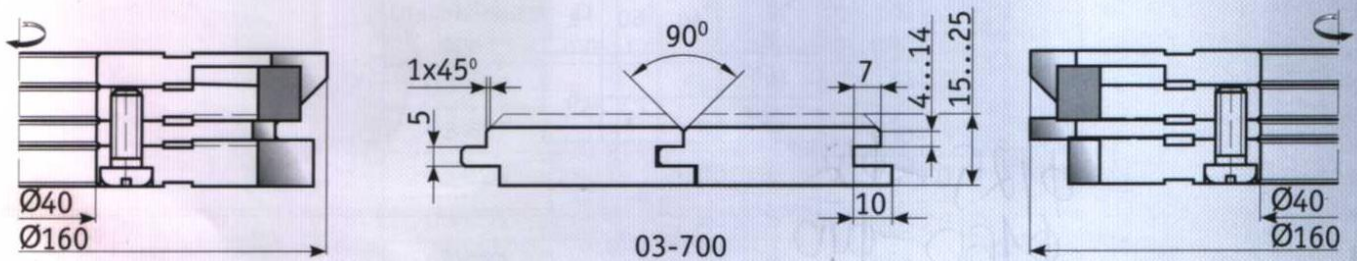
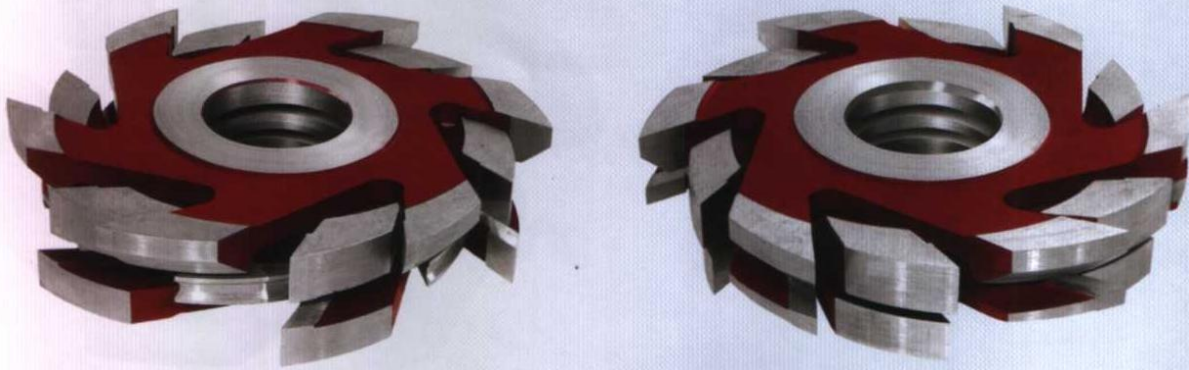

Комплект фрез для изготовления обшивочной доски “Американка”
 Материал режущей части - HSS

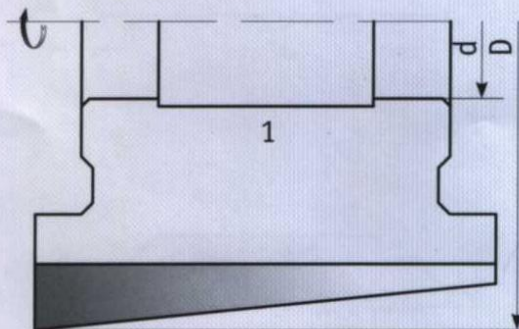

d \ D	40	60	z
160	x		6
180		x	

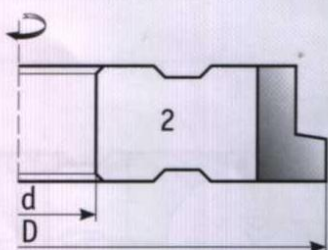

03-720

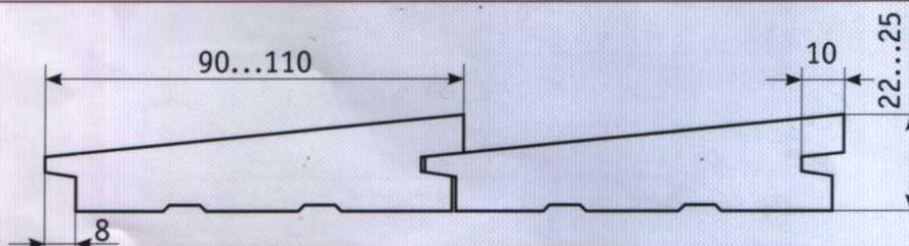
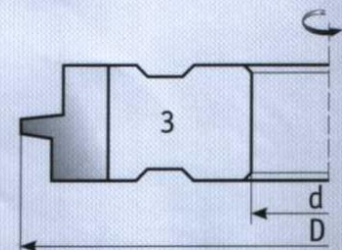



Комплект фрез для изготовления обшивочной доски "Block House"
Материал режущей части - HSS

Обозначение фрез	D, mm	d, mm	B, mm	z
03-721	125; 160; 180	32; 40; 60;	30	4; 6
			40	
			50	

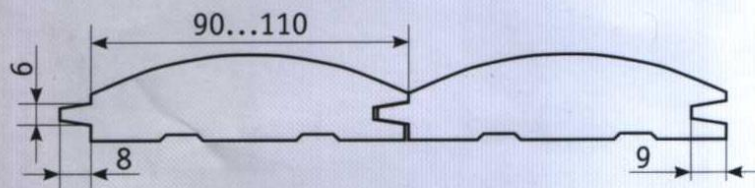
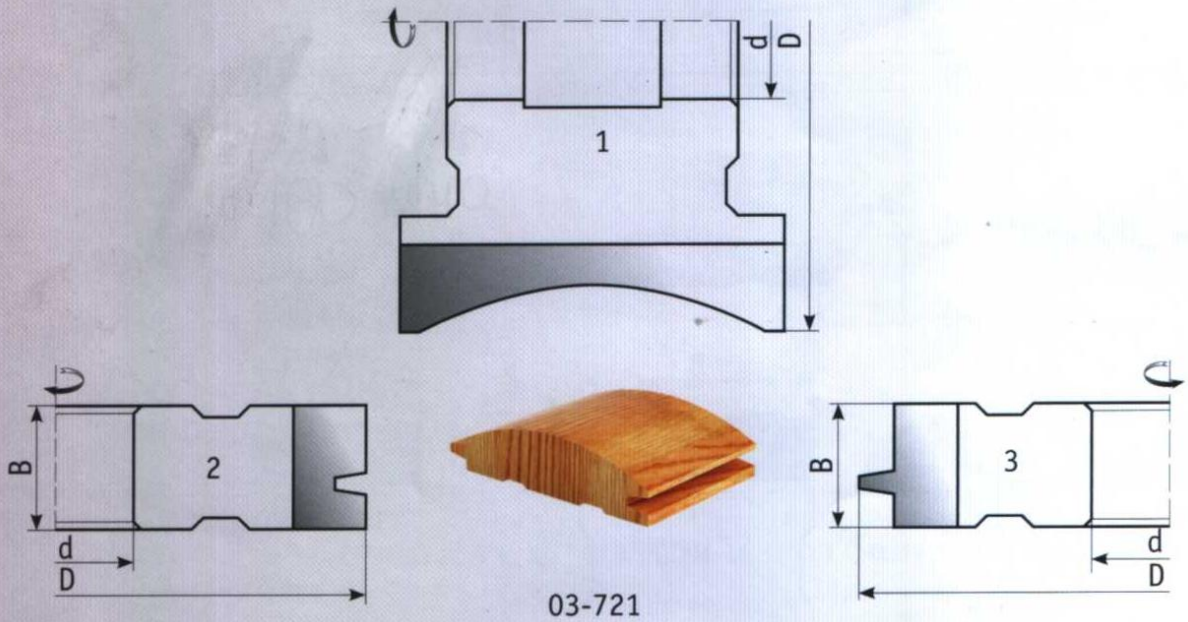
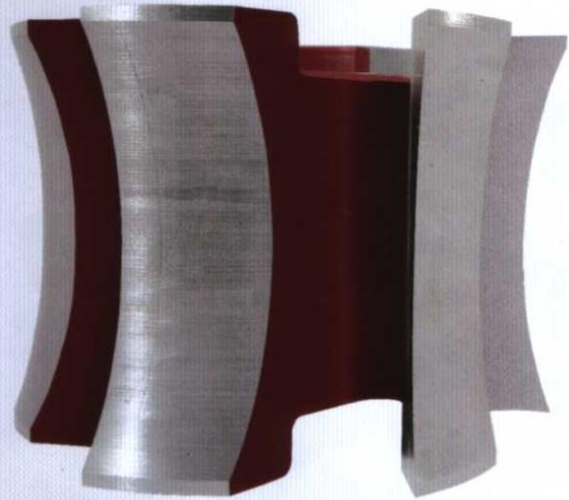



Фрезы для изготовления воздушного паза

Материал режущей части - HSS

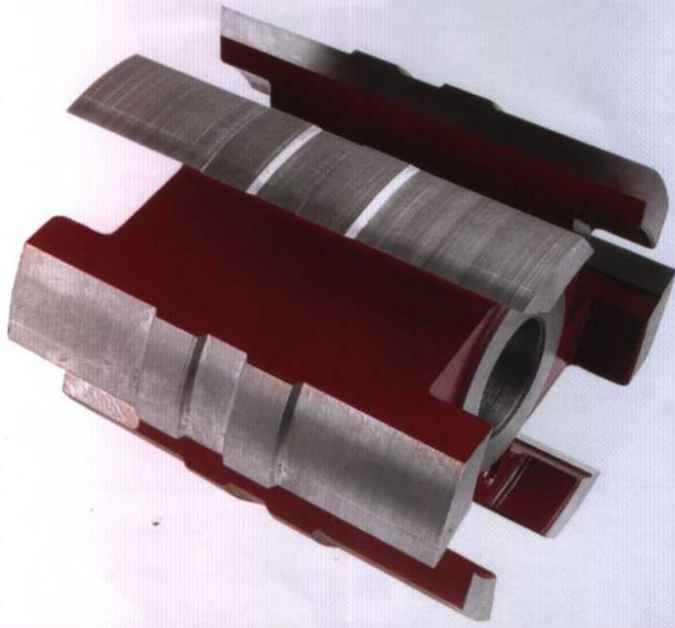

Обозначение фрез	D,mm	d,mm	B,mm	h,mm	z
03-801	125;160;180	32; 40; 60;	45...180	2...3	4;6
03-802					
03-803			20...180	3	
03-804					

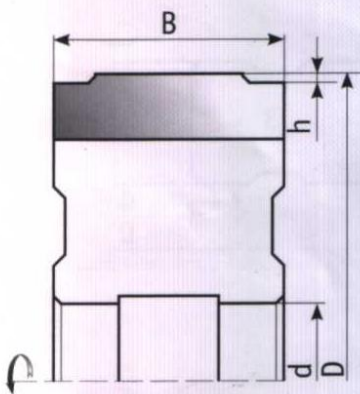

03-801

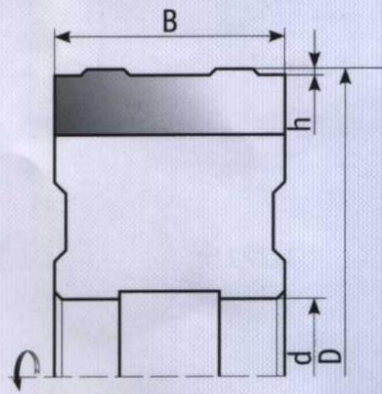

03-802

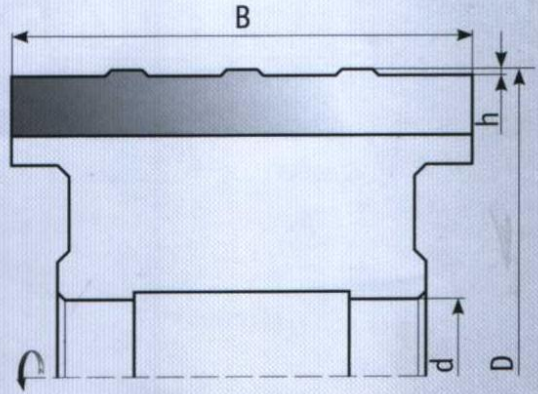

03-803

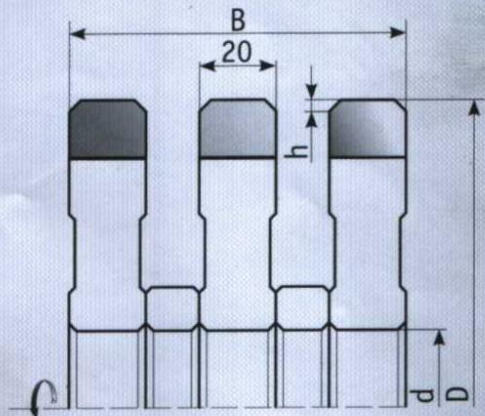

03-804



Комплект фрез для изготовления стенового бруса
Материал режущей части - HSS

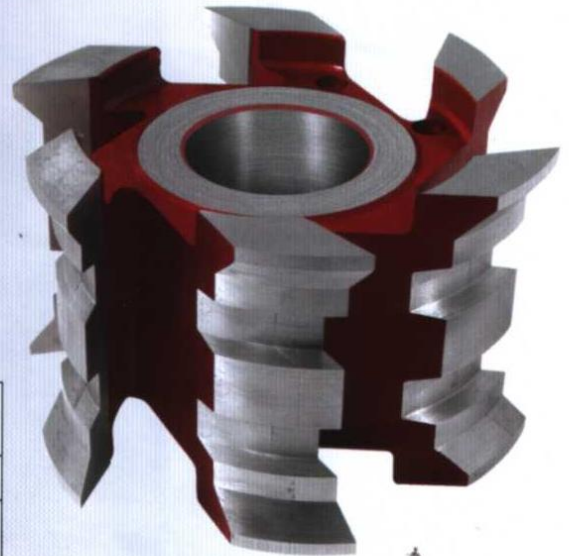
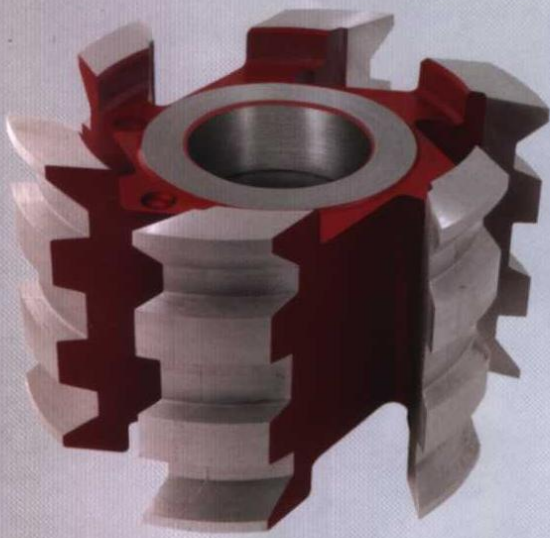

d \ D	32	40	60	z
125	x			4
160		x		6
180			x	

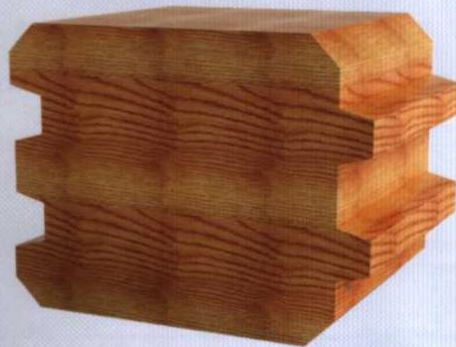
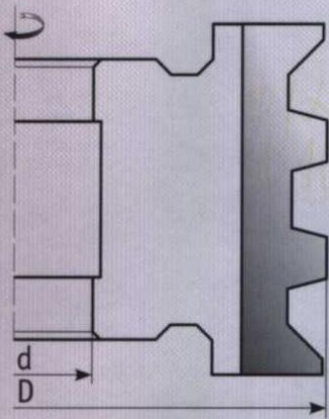

03-990

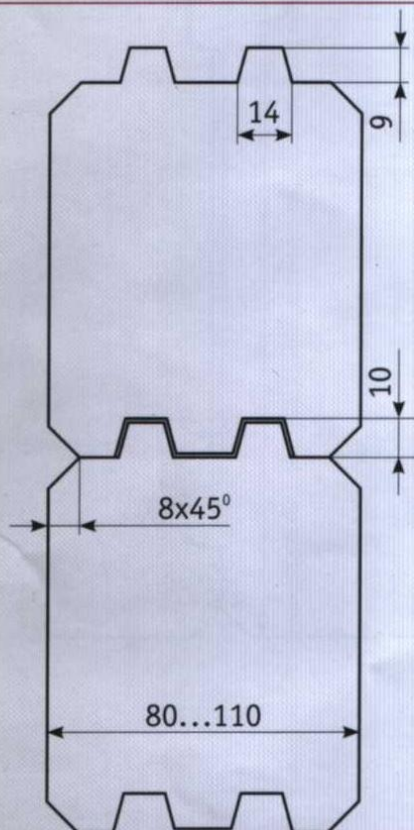
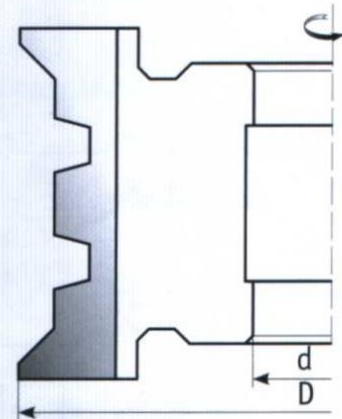



Комплект фрез для изготовления стенового бруса
Материал режущей части - HSS

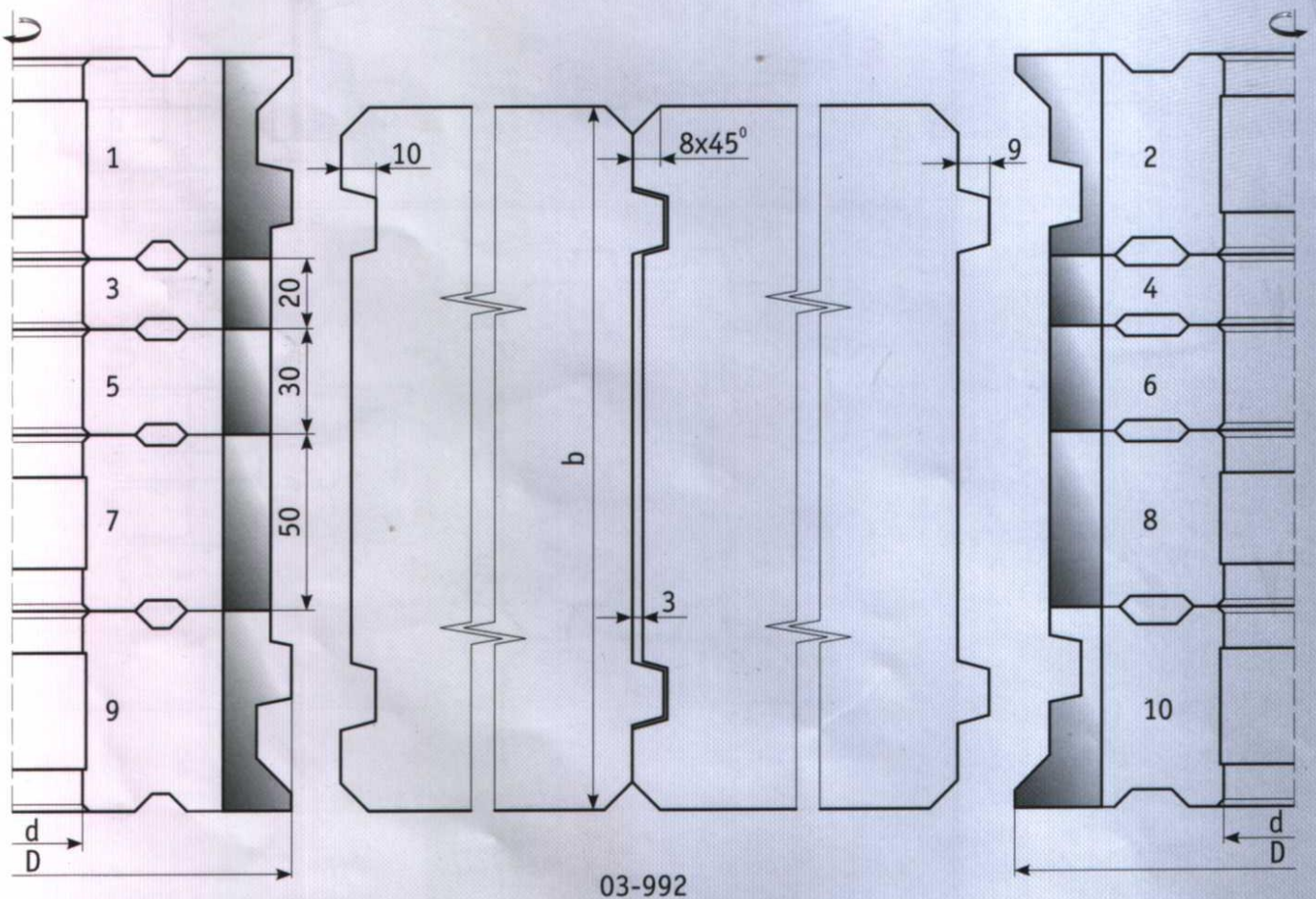
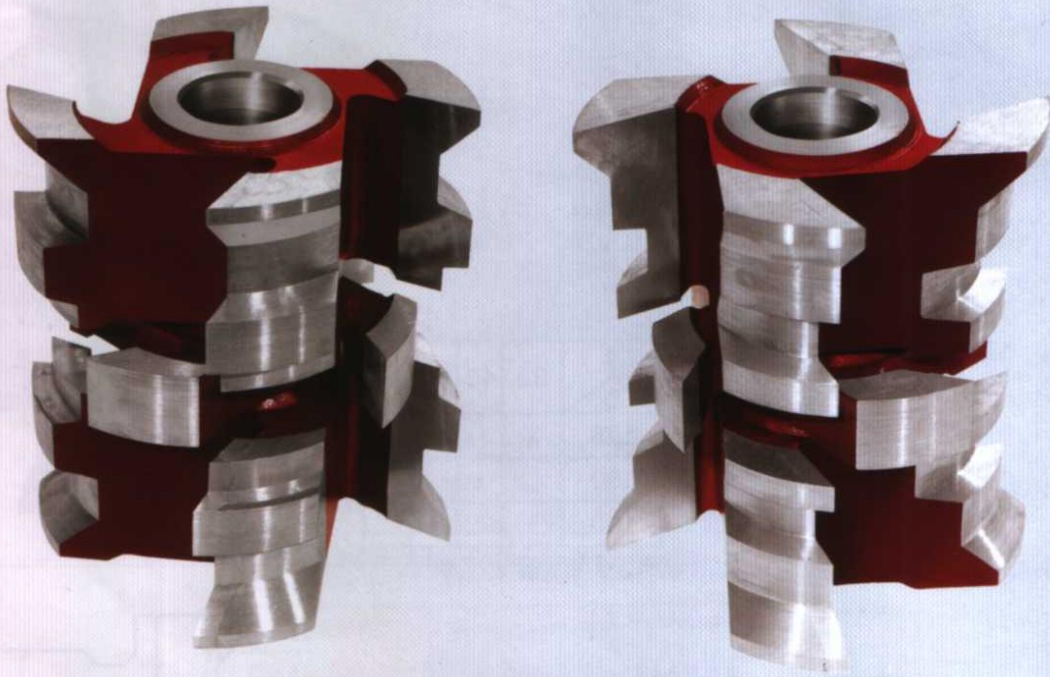



Комплект фрез для изготовления стенового бруса

Материал режущей части - HSS

№№ фрез	Ширина бруса "b"							D, mm	d, mm	z
	100	120	130	150	170	180	200			
1	■	■	■	■	■	■	■	130;160;180	32;40;60	4;6
2	■	■	■	■	■	■	■			
3	■	■	■	■	■	■	■			
4	■	■	■	■	■	■	■			
5	■	■	■	■	■	■	■			
6	■	■	■	■	■	■	■			
7	■	■	■	■	■	■	■			
8	■	■	■	■	■	■	■			
9	■	■	■	■	■	■	■			
10	■	■	■	■	■	■	■			

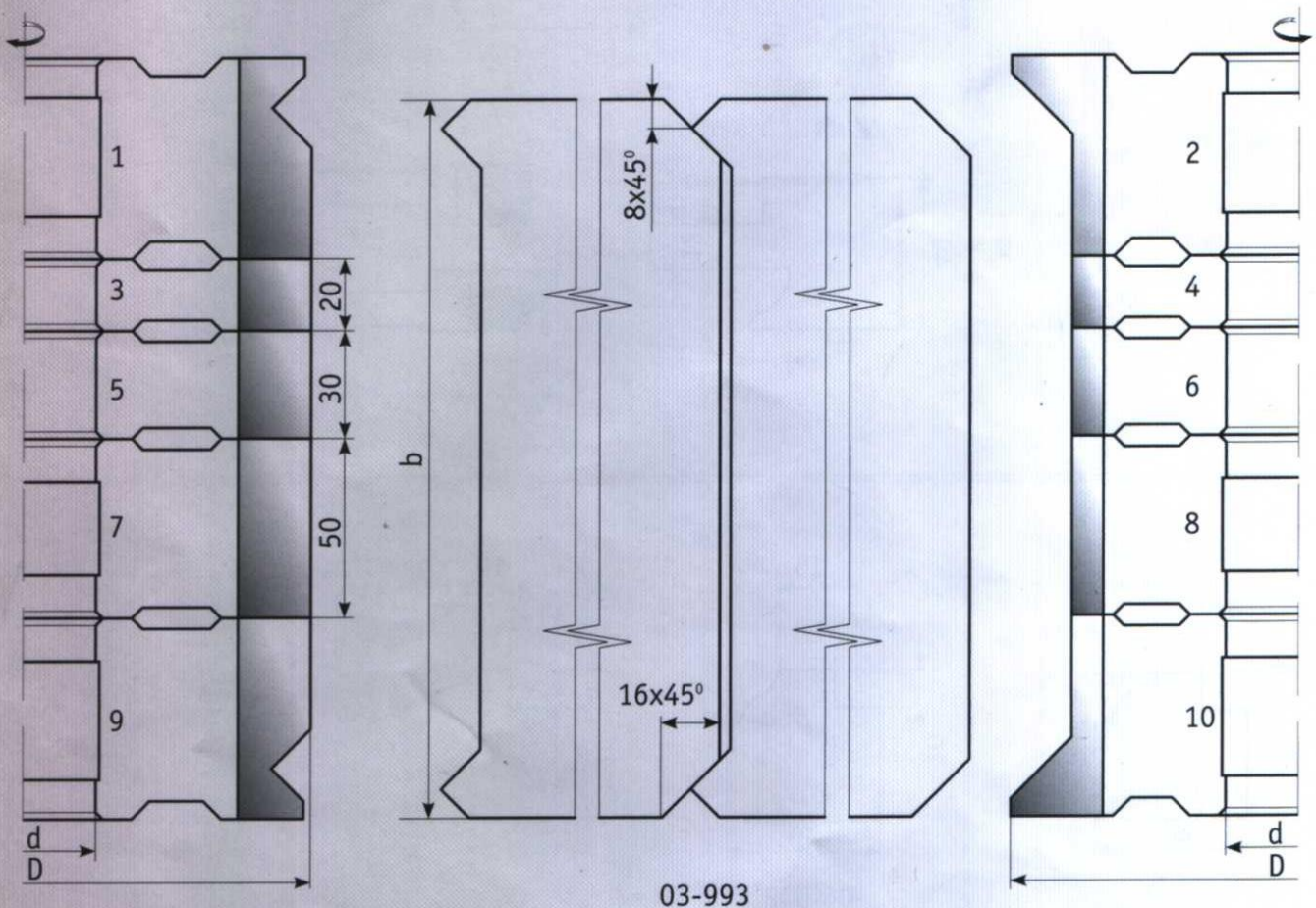

03-993



Комплект фрез для изготовления оконного блока

Материал режущей части - HSS

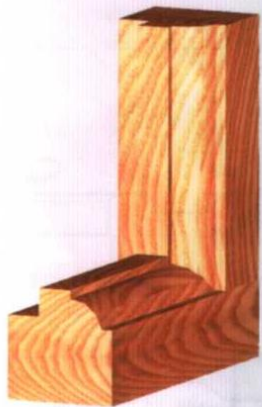
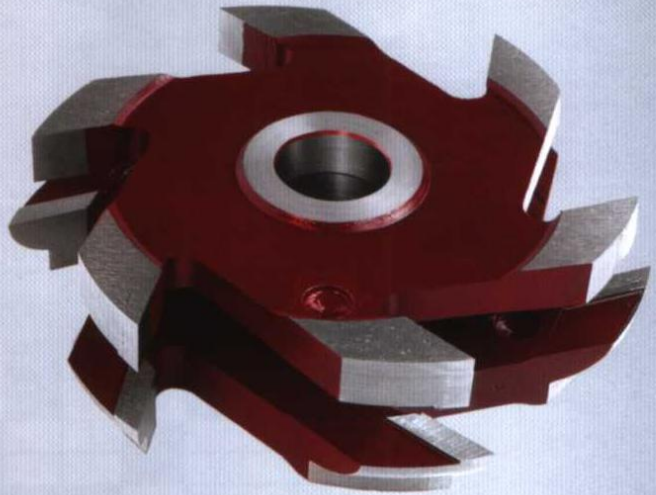
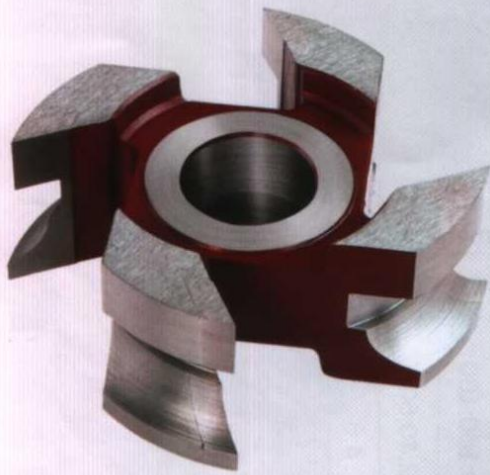

Обвязка

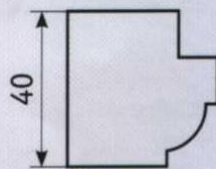

Исполнение 1

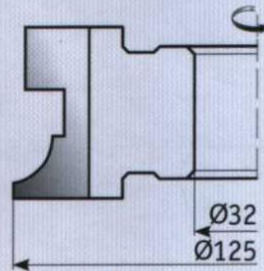

Исполнение 2

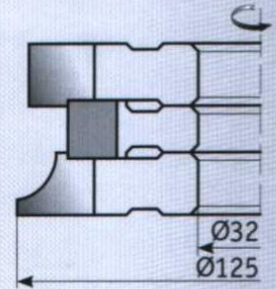

Шун

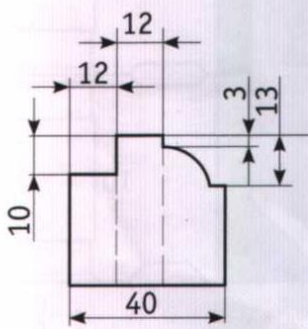
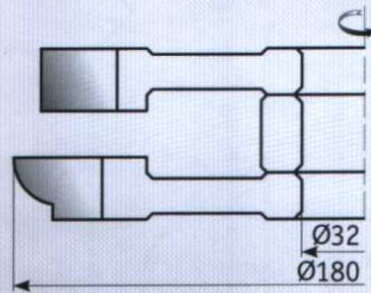
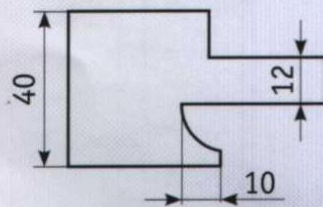

04-001

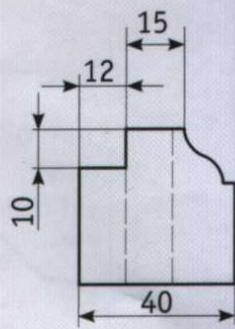

04-002

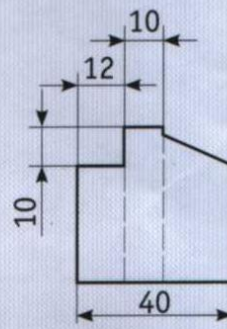

04-003

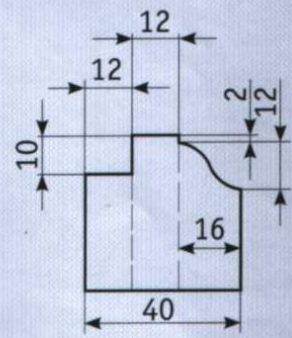

04-005



Комплект фрез для изготовления оконных блоков со стеклопакетами
Материал режущей части - HSS

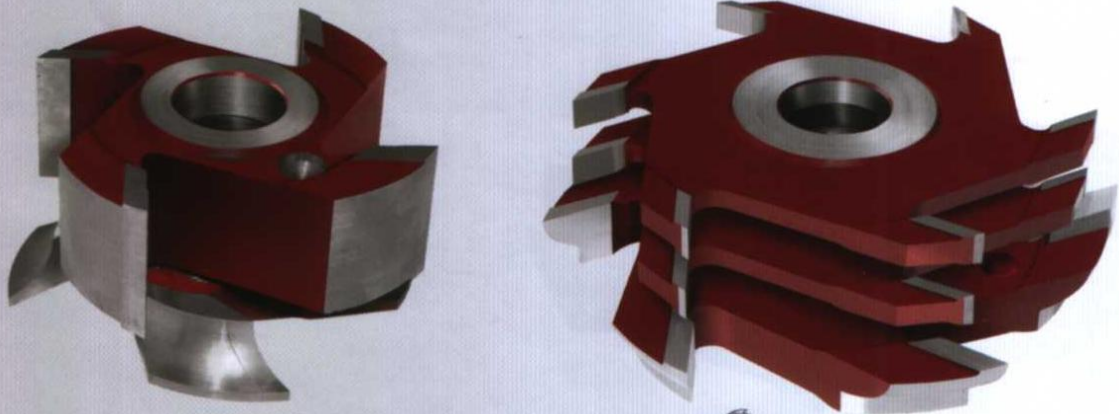

Обвязка

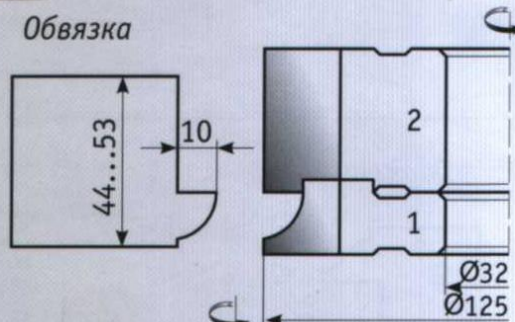

Двухшипное окно

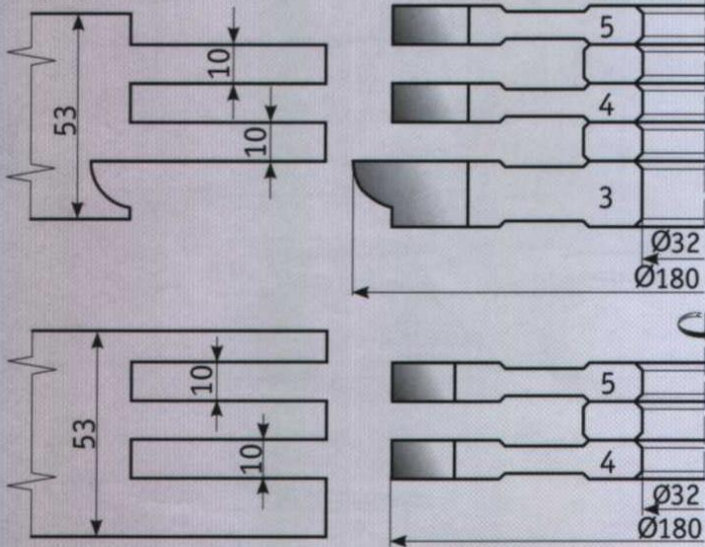

Одношипное окно

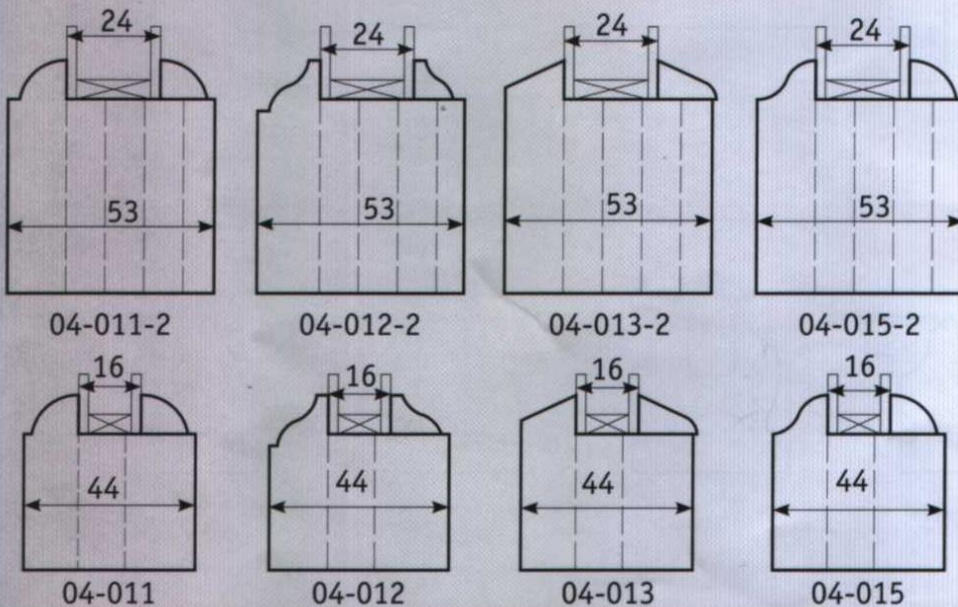
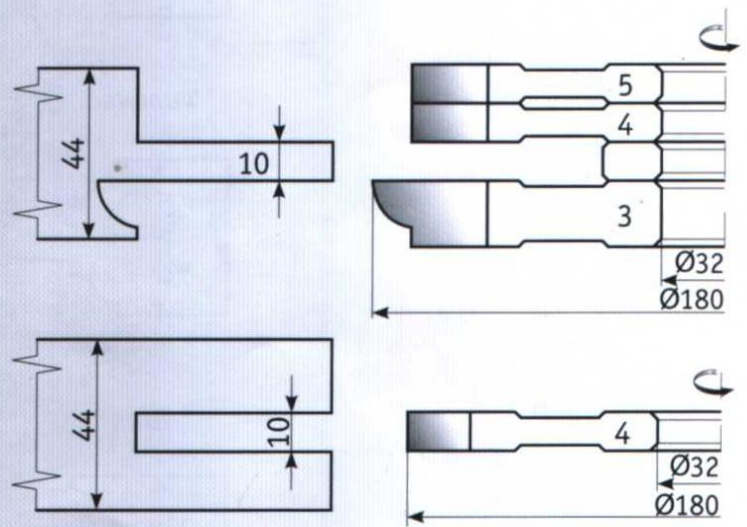



Комплект фрез для изготовления филёчатых дверей

Материал режущей части - HSS



Обвязка

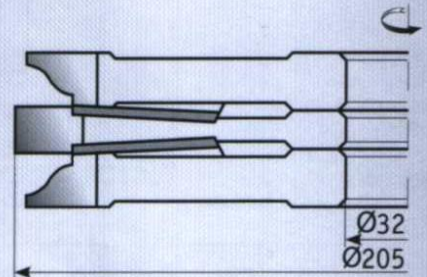
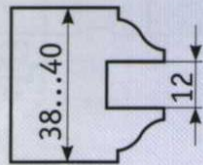

Филёнка

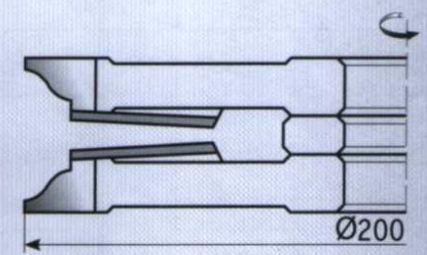
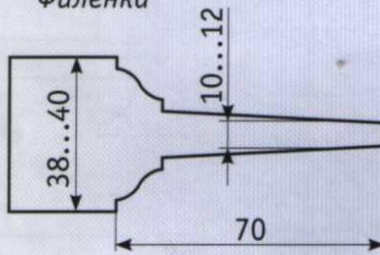

Шип

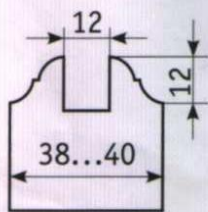
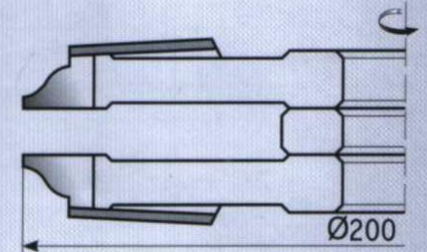
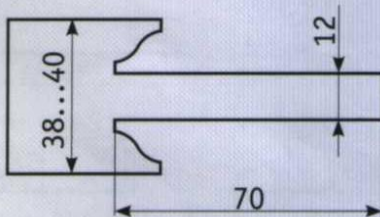

05-001

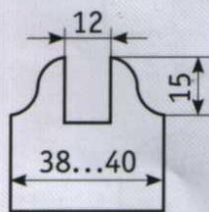

05-003

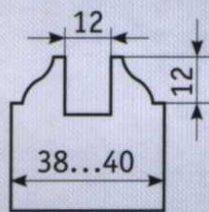

05-005

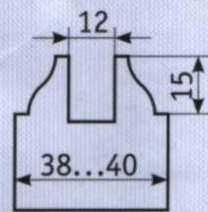

05-007

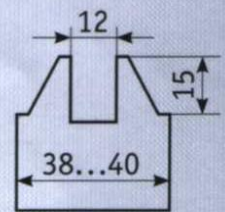

05-009



Комплект фрез для изготовления дверной обвязки

Материал режущей части - HSS

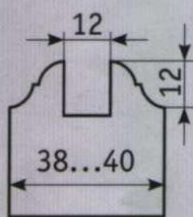
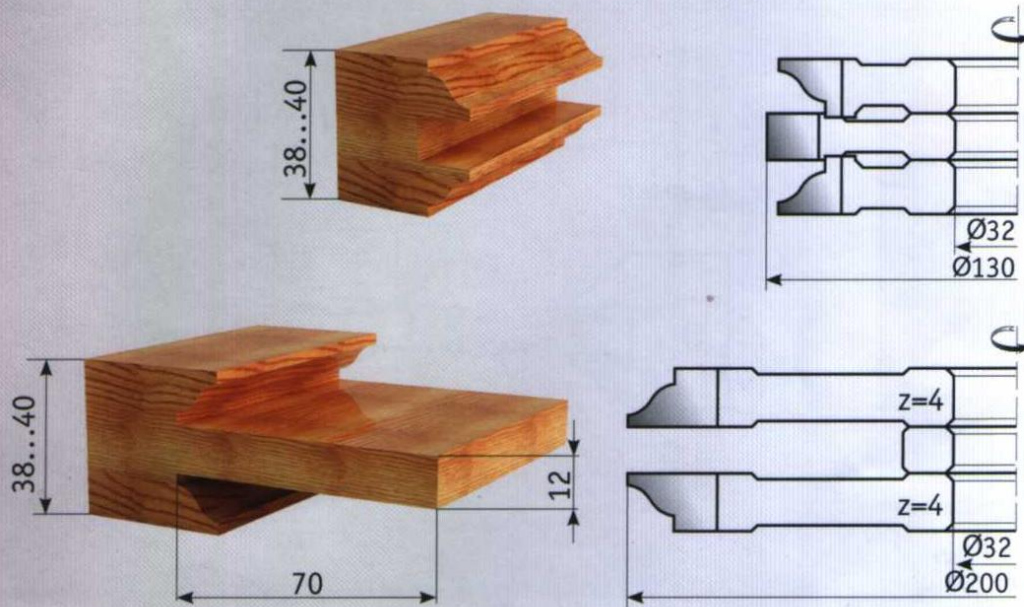

05-002

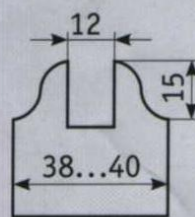

05-004

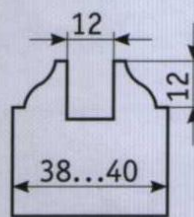

05-006

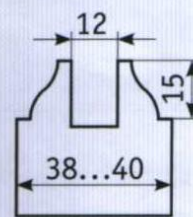

05-008

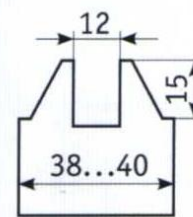

05-010



Комплект фрез для изготовления дверной обвязки с термошвом
Материал режущей части - HSS

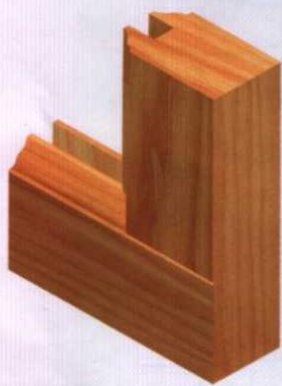
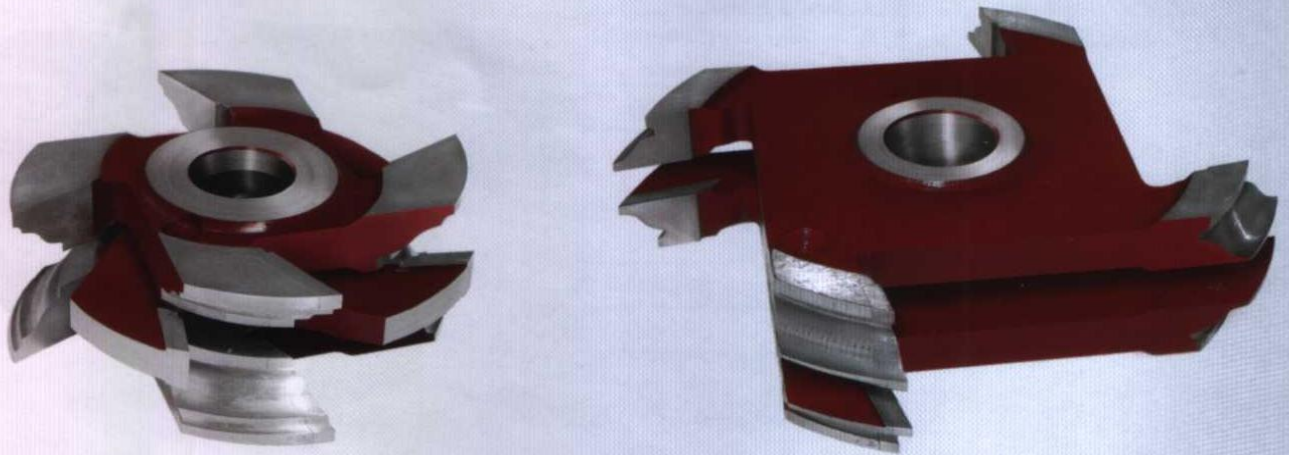

Обвязка

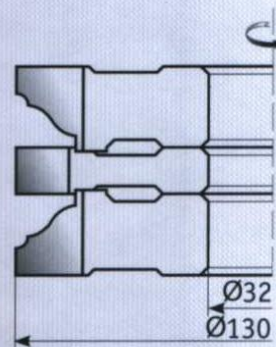
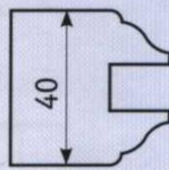

Шун

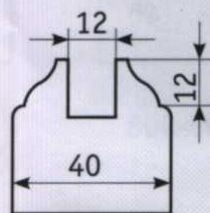
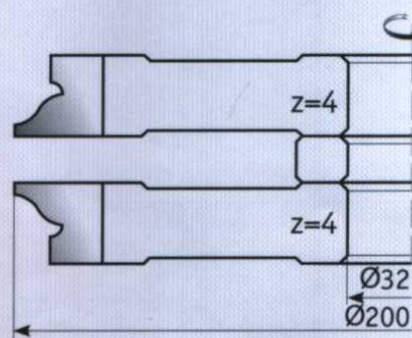
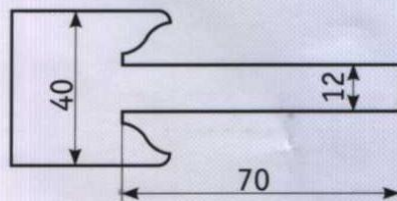

05-006.ТШ

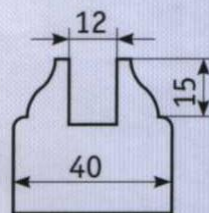

05-008.ТШ

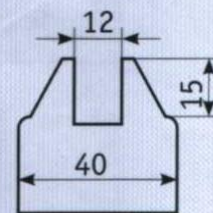

05-010.ТШ



Комплект фрез для изготовления дверей под остекление Материал режущей части - HSS

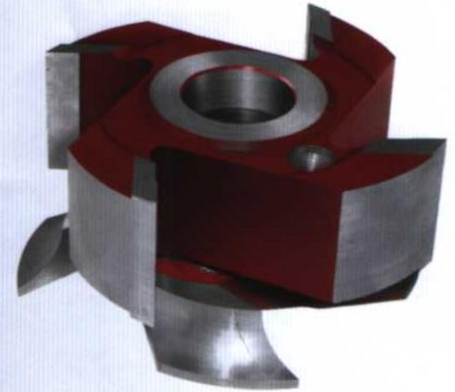

Обвязка под стекло

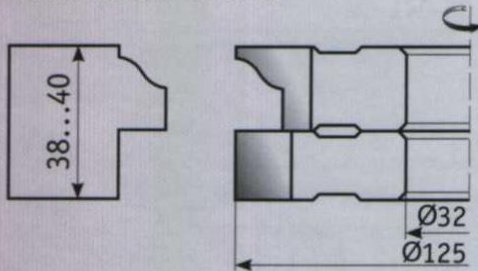

Шип под стекло

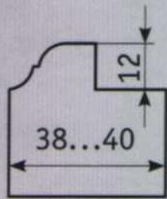
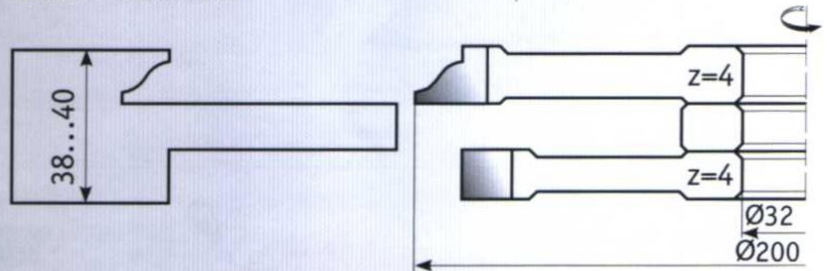

05-011

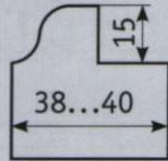

05-013

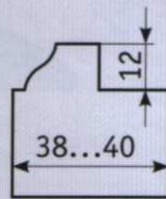

05-015

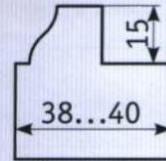

05-017



05-019

Комплект фрез для изготовления дверей под остекление с термошвом Материал режущей части - HSS

Обвязка под стекло

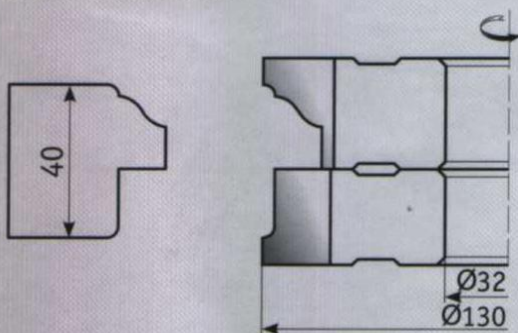

Шип под стекло

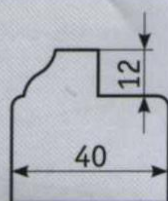
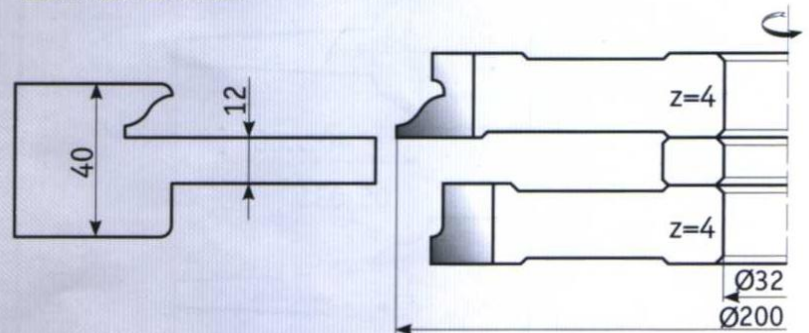

05-015.ТШ

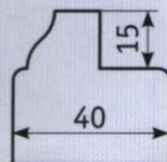

05-017.ТШ

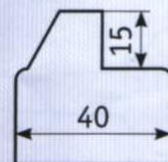

05-019.ТШ



Комплект фрез для изготовления дверной филёнки

Материал режущей части - HSS

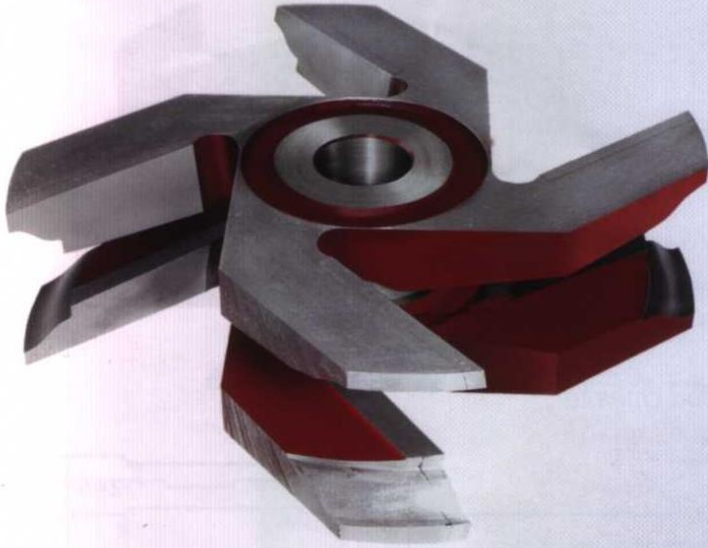

Обозначение фрез	D, mm	d, mm	z
05-030	125;160;180	32	4
05-031			
05-033			
05-035			
05-037			
05-040			
05-041			

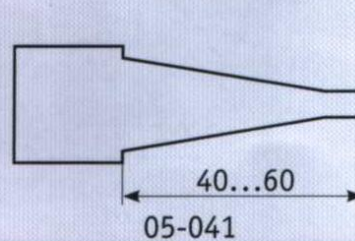
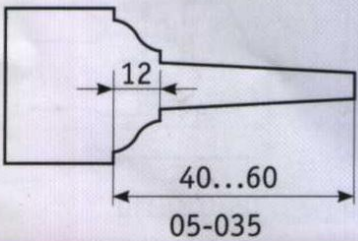
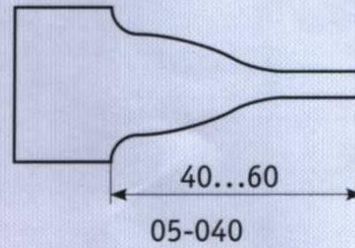
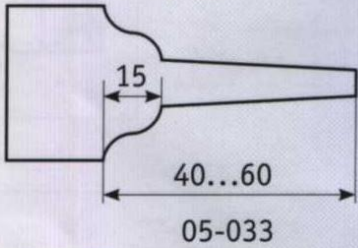
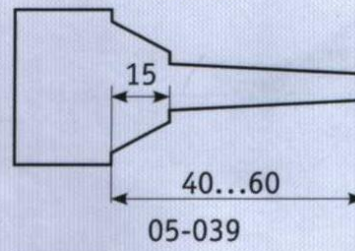
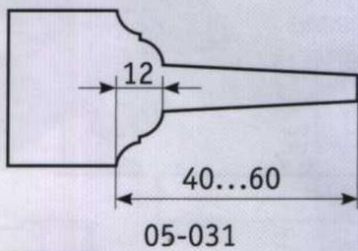
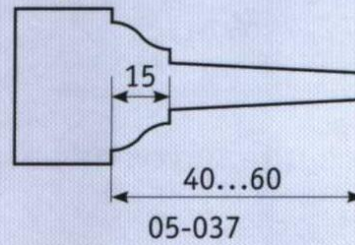
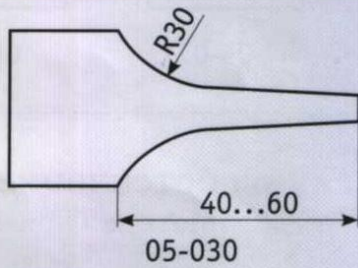
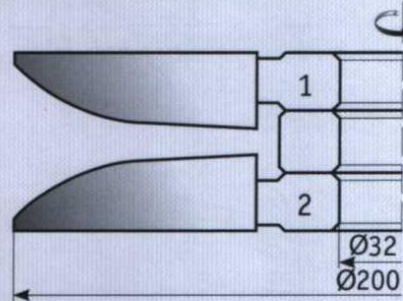



Комплект фрез для изготовления дверной коробки
 Материал режущей части - HSS

d \ D	40	60	z
160	x		4;6
180		x	

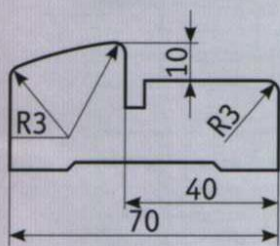
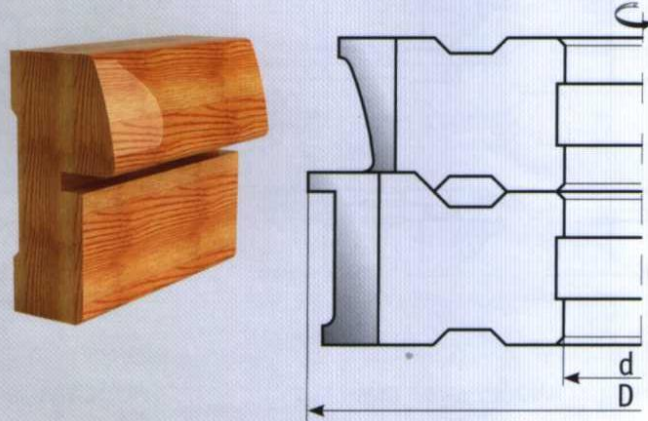

05-080

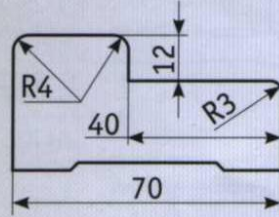

05-081

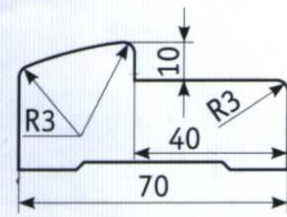

05-082

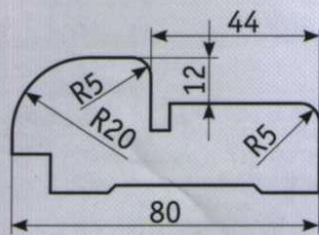

05-083

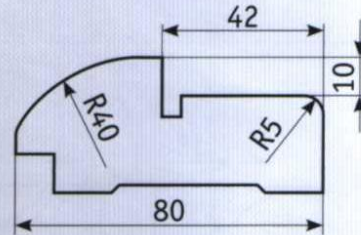

05-084



Комплект фрез для изготовления мебельной обвязки

Материал режущей части - HSS

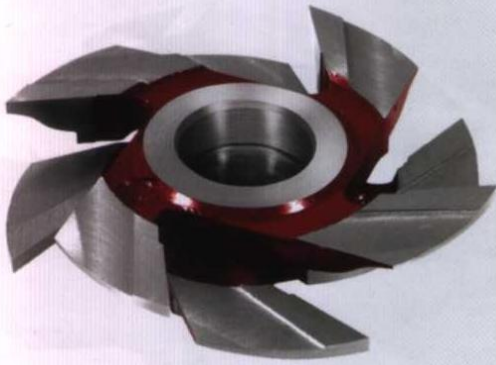

Обозначение фрез	D, mm	d, mm	z
08-001	125	32	4
08-002			
08-003			
08-004			
08-005			

Мебельная обвязка

Исполнение 1

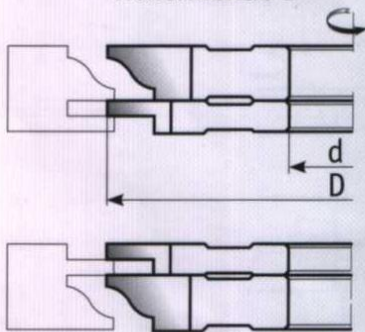

Исполнение 2

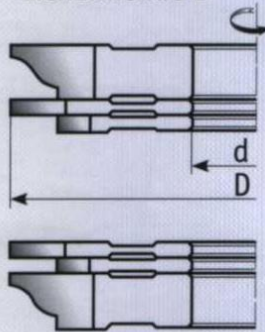

Мебельная обвязка с термошвом

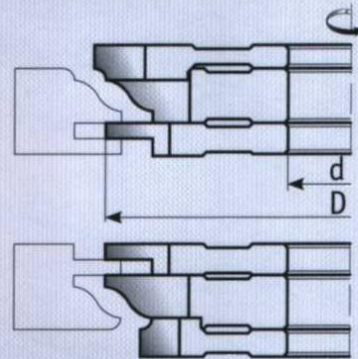

Мебельная обвязка под стекло

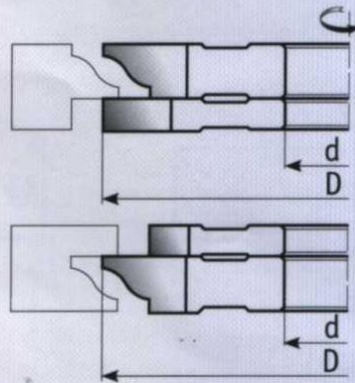

Мебельная обвязка под стекло с термошвом

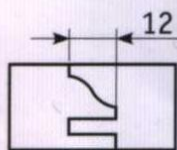
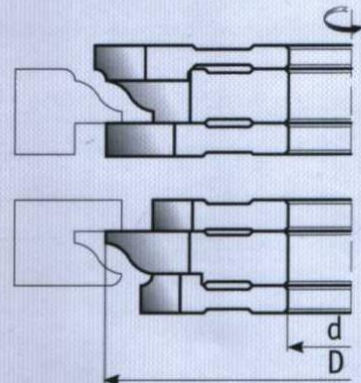

08-001

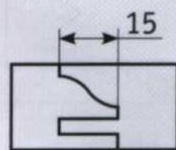

08-002

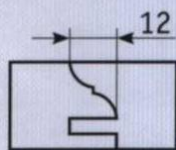

08-003

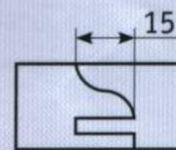

08-004

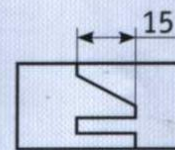

08-005



Фрезы для производства мебельной филёнки Материал режущей части - HSS

Обозначение фрез	D,mm	d,mm	b,mm
08-030	160;180;	32	4
08-031			
08-032			
08-033			

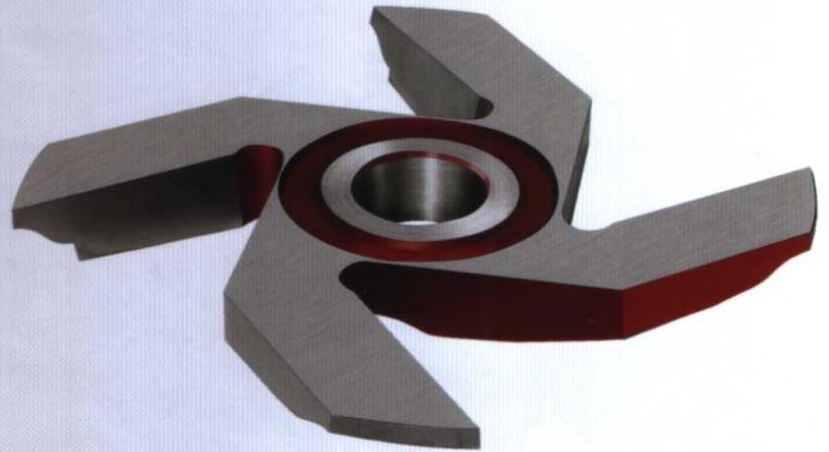

08-030

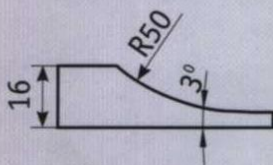

08-031

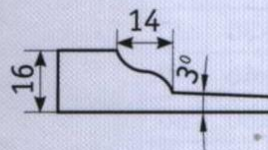

08-032

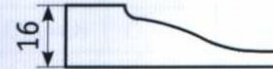

08-033

Фрезы для производства мебели Материал режущей части - HSS

Обвязка

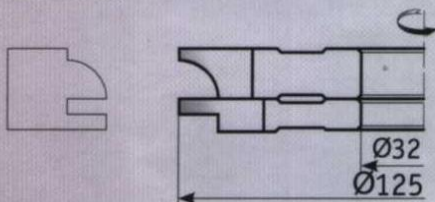

Шун



08-100

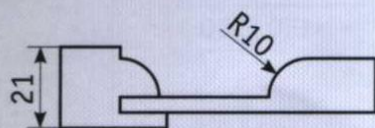

Филёнка

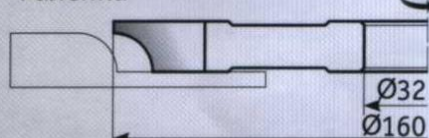

Обвязка

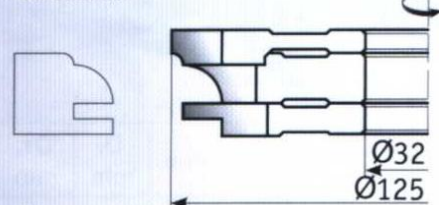

Шун



08-100 ТШ



Фрезы цилиндрические сборные

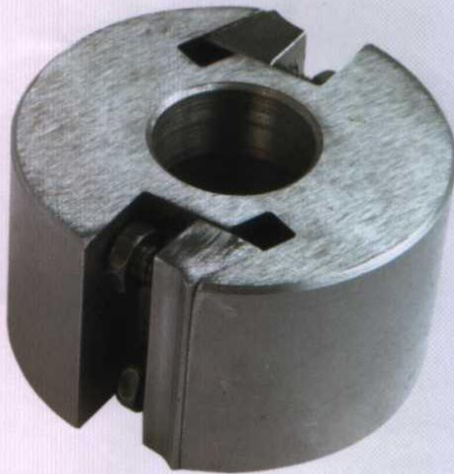

Исполнение 1

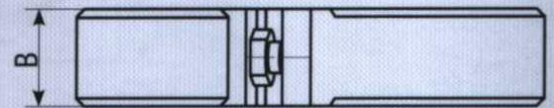
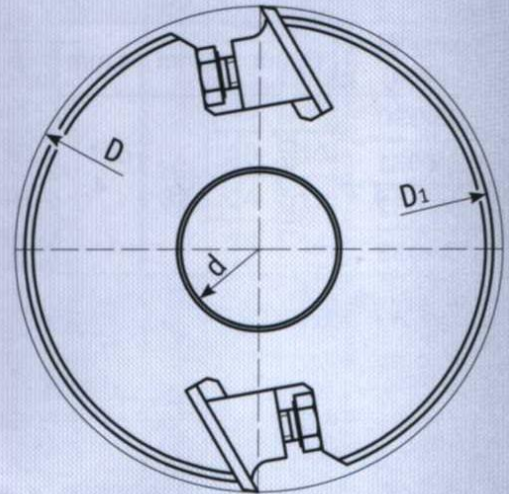

Обозначение				В, мм
Фреза	Корпус	Клин	Нож	
09-025	К-025	Кл-025	32x3x25	25
09-030	К-030	Кл-030	32x3x30	30
09-040	К-040	Кл-040	32x3x40	40
09-050	К-050	Кл-050	32x3x50	50
09-060	К-060	Кл-060	32x3x60	60
09-070	К-070	Кл-070	32x3x70	70
09-090	К-090	Кл-090	32x3x90	90
09-100	К-100	Кл-100	32x3x100	100
09-110	К-110	Кл-110	32x3x110	110
09-120	К-120	Кл-120	32x3x120	120
09-150	К-150	Кл-150	32x3x150	150

Исполнение 2

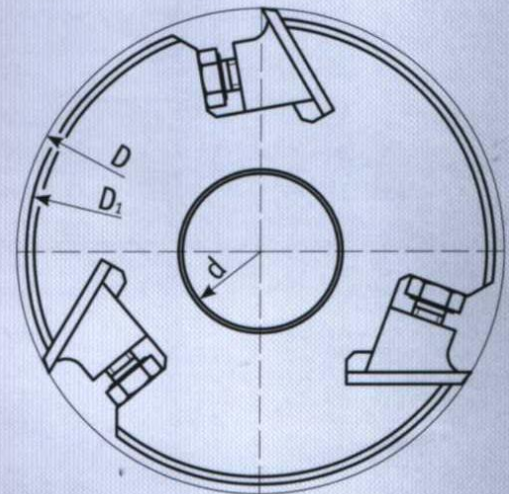

Исполнение 3

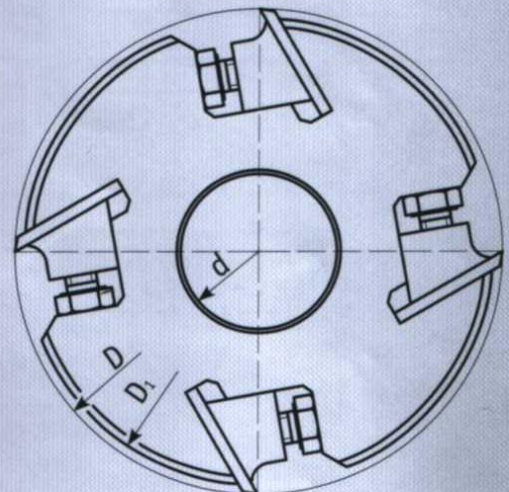

Исполнение	D, мм	D1, мм	d, мм
1	100	90	32
2			
3	130	120	32;40
	140	130	
	160	150	

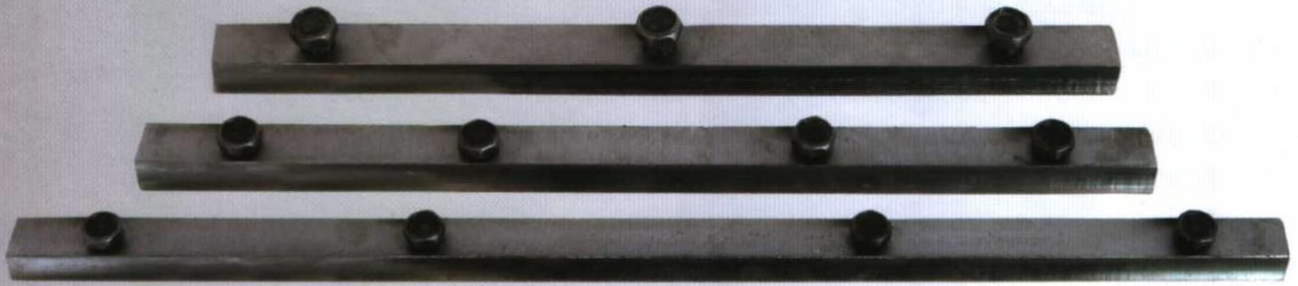

L,mm	25	30	40	50	60	70	90	100	110	120	150	200	250	300	350	400	450
Винт М8	2 шт.											3 шт.			4 шт.		

Валы цилиндрические сборные

Обозначение вала	D, mm	d, mm	B, mm	z
10-200	100	32	200	3
10-250			250	
10-300			300	
10-350			350	
10-400			400	



